

Zentech....+40 Years of Experience

Providing Innovative Engineering Solutions

Engineering Consulting



- Drilling Rigs: Semi-submersibles, Jackups, Drillships, Drill Barges
- Fixed Facilities: Jackets, Topsides, Modular Rigs
- Offshore Production Units: Jackups, MOPUs, SPARs, TLPs, FSOs and FPSOs

Construction Management

- On-site construction management professionals
- Support for shipyards, fabrication yards
- Assistance for Class Society approval



EPC Contracting

- Engineering/Procurement/Construction capability
- Range of Services up to full turn-key responsibility
- Proven experience in United States and internationally



Engineering Software

- ZAIMS™ Zentech Asset Integrity Management System
- PADDS® System for Project Design Cycle Management
- ZenMoor™ Mooring Analysis
- Neptune™ Motion Analysis
- Z-Riser™ Rigid Riser Finite Element Analysis



On-Board Software

- LosJack™ load & stability for jackups
- LoSemi™ load & stability for semis
- LoShip™ load, stability & longitudinal strength for ship-shapes & barge-like vessels
- ZenMAP™ mooring advisory for semis
- ZenMAS™ real-time mooring advisory for SPARs and similar units
- WMS™ weight management for SPARs and similar units

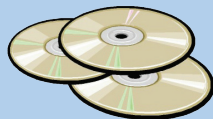

Zentech Home Office in Houston, Texas

Modular Platform Rig Designs

- Available designs for 1000HP, 1500HP, 2000HP and 3000HP
- Modular, light weight and self-erecting
- Five packages: Drilling; Power & Support Systems; Pipe Rack; Accomodations; Helideck
- Designs are based on new technology



New Build Designs

- 4-leg self-propelled jackup designs for multi-purpose service work and offshore wind farm installation
- 3-leg jackup designs for drilling in 350-500 Ft. (106.7m-152.4m) WD
- Additional details on reverse side



Semi-Submersibles & Drillships

- Deepwater design Super EVA, EVA-Plus
- Multiple Semi-Submersible conversions
- Multiple Drillship conversions



Zee Rig 1

Semi-SWATH vessel ideally suited for:

- Accommodations vessel
- Sub-sea ROV or dive support work
- Commuter or shuttle passenger service
- General offshore service support
- Offshore cable laying
- Offshore wind farm maintenance & service work



Zee Rig 3



- Configurable as marine crane jackup barge or as Self-Propelled DP-II jackup vessel for wind farm installation work
- Variable Deck Load 5,500 US tons (4,990mt)
- Capable of transporting 10 complete wind turbines: towers, nacelles and blades
- Berthing for 45 persons (marine and client)

Zee Rig 1



- Ultra stable Semi-SWATH vessel • Self-propelled and DP
- Length 237 Ft. (72.2m), Breadth 95 Ft. (29.0m)
- U.S. Flag vessel, Jones Act compliant

Ideally suited for:

- Offshore wind farm service work
- Accommodations or Floatel vessel
- Seismic survey
- Commuter or shuttle passenger service
- Sub-sea ROV or diving support
- General offshore service support

Zee Rig 3

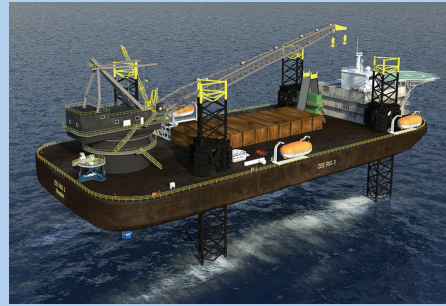

- Vessel dimensions 400 / 210 / 29 Ft. (121.9 / 64.0 / 8.8m)
- Rated for 200 Ft. (61.0m) water depth; options to 250 Ft. (76.2m)
- Variable load 11,003 Kips (4,990mt); net variable load 10,584 Kips (4,800mt)
- Jacking speed 1.5 fpm (0.46 mpm)
- Available as self-propelled DP-II

Semi-Submersibles and Drillships



Paul Wolff conversion



Roger Eason conversion

Zentech Proprietary New-Build Designs

Jackup Rigs

					
Nominal Capacities	Z-210-WF	Z-210	R-450D	R-550D	Z-636
Water Depth (Ft., m)	210 (64m)	210 (64m)	350 (106.7m)	400 (121.9m)	500 (152.4m)
Drilling Depth (Ft., m)	N/A	20,000 (6,096m)	30,000 (9,144m)	30,000 (9,144m)	30,000 (9,144m)
Operating Variable Deck Load (Kips, mt)	N/A	5,000 (2,268mt)	11,000 (4,989mt)	11,000 (4,998mt)	18,000 (8,163mt)
Cantilever Capacity (Kips, mt)	N/A	2,000 (907mt)	2,200 (998mt)	3,500 (1,587mt)	3,500 (1,587.3mt)
Cantilever Reach (Ft., m)	N/A Offshore Wind Farm Installation Vessel	45+/-15 (13.7m +/-4.6m)	75+/-15 (22.9m +/-4.6m)	80 +/- 20 (24.4m +/- 6.1m)	80 +/- 20 (22.9m +/-6.1m)
Hull Length/Breadth/Depth (Ft., m)	272 / 174 / 20 (82.9/53.0/7.3)	224 / 144 / 20 (68.3/43.9/6.1m)	240 / 212 / 26 (73.2/64.6/7.9m)	260 / 261 / 27 (79.2 / 79.6 / 8.2m)	287 / 284 / 30 (87.5/86.6/9.1m)
Quarters in 2-Person Rooms	80	100	120	150	150
Derrick Footprint (Ft., m)	N/A	30 x 30 (9.1 x 9.1m)	32 x 35 (9.8 x 10.7m)	40 x 45 (12.2 x 13.7m)	40 x 40 (12.2 x 12.2m)



14800 St. Mary's Lane, Suite 270
Houston, Texas 77079

Tel: +1 281 558 0290
Fax: +1 281 558 0295

E-mail: zentech@zentech-usa.com

www.zentech-usa.com

Six International Locations:

- Houston, Texas • Mexico City, Mexico • Rio de Janeiro, Brazil • Sharjah, United Arab Emirates • Chennai, India • Mumbai, India



 **ZENTECH INCORPORATED**
INNOVATIVE ENGINEERING SOLUTIONS

14800 St. Mary's Lane, Suite 270
Houston, Texas 77079 USA
Phone (281) 558-0290
Web www.zentech-usa.com
Email zentech@zentech-usa.com

Corporate Overview

BACKGROUND

Founded in 1978, Zentech is a Houston-based design and consulting engineering company providing services to the offshore oil and gas industry. Zentech presents itself as a small, efficient, and cost-effective group of professionals specializing in providing services to the marine, petroleum, and construction industries.

OPERATIONAL PHILOSOPHY

Fundamental to Zentech's organizational and operational philosophy is its commitment to staying on the cutting edge of knowledge. This is what keeps us and our clients ahead. We ensure this by continually upgrading existing competencies and creating new ones, at the organizational level, as well as the individual level. Zentech has in place specific mechanisms to turn individual and group expertise into organizational knowledge, and to draw business value from this knowledge by using it to upgrade and enhance organizational capabilities.

The core strength of Zentech is based on a strong culture of teamwork and professionalism, which encompasses respect for the individual, integrity, efficiency, trust, client focus, and a pursuit of excellence. Our values are non-negotiable. They are never to be compromised. For us, our values are our foundation. They help guide our actions and decisions.

VISION

Zentech shall be a professionally managed engineering consulting firm, committed to total customer satisfaction. Zentech employees shall be an innovative, entrepreneurial, and empowering team, consistently creating value and attaining global benchmarks. Zentech shall foster a culture of caring, trust, and continuous learning.

MISSION

Zentech shall pursue the creation of value for its clients, employees, and society at large.

QUALITY POLICY

At Zentech, we believe that quality is a culture, expressed in the way we interact with, and cater to, the needs of our clients and in the services we deliver. Zentech's quality assurance program is key to ensuring the integrity of our engineering solutions and allows us to provide our services to a wide variety of clients worldwide. Our projects have received approval from the following regulatory agencies: DnV, ABS, Lloyd's, BV, DeN, GL, NPD, NMD, USCG, and SOLAS. Our emphasis on quality is reflected in the following policies:

- Recognize and respect clients' right to receive quality services, on time, and within budget.
- Endeavor to exceed clients' expectations of competence, performance, delivery schedule, and value, thus becoming their preferred choice for repeat business.
- Strive constantly to improve upon our standards of quality, efficiency, and productivity.
- Achieve shared objectives in an atmosphere of fairness, integrity, dignity, and courtesy towards clients, employees, and competitors.

Zentech adheres to the highest standards of ethical business behavior, and our reputation for adhering to these standards is one of our most valuable assets. Our core values are used as a touchstone for our daily work.

We suggest, appreciate, and welcome the opportunity to meet and discuss your specific project needs and develop solutions for your consideration. Zentech's assistance is offered on a project-by-project basis, or as an overall engineering assistance program.

Engineering Capabilities

Zentech's main engineering disciplines include Structural Engineering, Naval Architecture and Marine Engineering, and Mechanical and Electrical Engineering. Our range of services include (but not limited to) the following:

STRUCTURAL ENGINEERING

- Analysis and design of fixed offshore platforms including jackets, topsides, helideck, accommodation modules etc.
- Reassessment of existing offshore oil platforms, jackup rigs, semisubmersibles, etc. and reserve strength assessment
- Jackup rig conversion and modifications including slot to cantilever conversion, extension of cantilevered rigs, increase in leg length, drilling package modifications, and other system upgrades
- Design and analysis of floating structures including semisubmersibles, TLPs, Spars, FPSOs, etc.
- Floating structures for offshore operations and construction, such as derrick / crane barges, pipelay barges, shear-leg lift vessel, multipurpose barges, etc.
- Load out and transportation analysis including design of grillage and sea fastening arrangements

NAVAL ARCHITECTURE AND MARINE ENGINEERING

- Stability Analyses (intact and damage)
- Mooring Analysis (static, quasi-static, dynamic, and fatigue)
- Motions Analysis (radiation-diffraction)
- Loading Conditions and Preload / Ballasting Procedures
- Longitudinal Strength
- Displacement and Payload Upgrades
- Tonnage and Freeboard Calculation
- Loadline Calculations
- Deadweight Survey and Inclining Experiments

MECHANICAL AND ELECTRICAL ENGINEERING

- Piping Systems
- Firefighting System
- Riser Tensioners Upgrade
- Skidding System Design and Modifications
- Mechanical Locking System
- HVAC System
- DP Systems
- Electrical System Design and Calculations
- Fire Detection Systems
- Instrumentation, etc.

CAD SERVICES

Zentech offers CAD Services that produce specialized AutoCAD design, detailing, and fabrication drawings for marine, offshore, and commercial applications

NEW JACKUP RIG DESIGNS

Zentech has developed three new jackup rig designs: the **Z-210**, **R-550D**, and **Z-636**. These rigs are designed for superlative performance and easy construction. The R-550D and the Z-636 rigs include the patented "ZENLOCK" jacking system. For more information on any of our new rig designs, please contact Zentech.

Engineering Projects

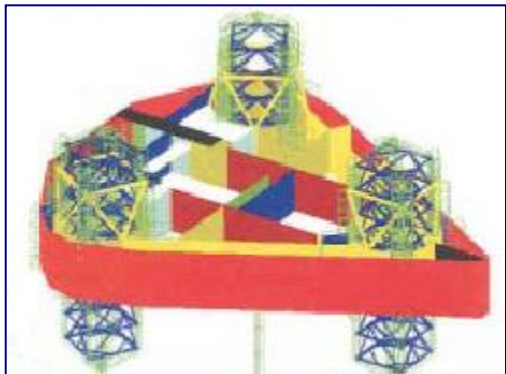

Conversion from slot-type to cantilevered jackup drilling rigs:

Several dozen rigs have been studied and converted from slot-type to cantilevered jackup drilling rigs. Closing of the slot, skid rail and skid rail bulkhead design, design of pushups and hold downs.

Some of these projects were for the national drilling companies of various countries. These rigs were of various designs which include LeTourneau, Hitachi, Levingston, Bethlehem, F&G, and Baker Marine with different water depth capabilities.

Other jackup rig modifications:

Design of subbase and substructure areas, drill floor design and modifications, derrick and setback area modifications, raw water tower design, quarters modifications, helideck design and modifications, leg extensions and modifications for deeper water and harsher environments.

Reassessment and Life Extension for 26 Jackets in the Bay of Campeche including pushover analyses for wave and seismic loads, spectral fatigue analysis, and risk-based inspection planning.

Jacket Fatigue Analysis: Verify existing jacket for fatigue assessment for water depth of 148 ft.

Drilling Platform Jacket Analysis: Design & Drawings for 185 ft water depth.

Design of a Drilling Platform Jacket Structure in the GoM in 243 ft water depth.

Design of a Drilling Platform Jacket in 122 ft water depth.

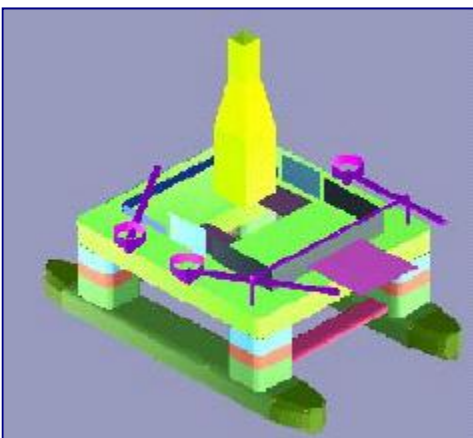
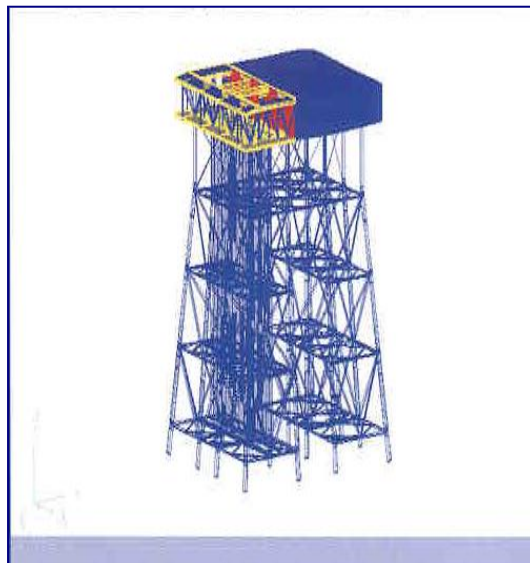

Conversion of an accommodation semi-submersible to a drilling unit: An accommodation semisubmersible was converted from 600 plus man accommodation unit to a 7500 ft operating water depth DP class III drilling rig. The rig has been operating successfully for BP in Gulf of Mexico.

Enhancing the water depth capability of Pentagon class semi-submersibles:

Modifications to the hull and systems to enable the semisubmersible to drill in deeper waters. P-Tank rack, lifeboat structure, pipe rack and riser rack area, and crane upgrade designs. Increased quarters capacity, enhanced variable load capacity.

Other semisubmersible rig modifications: Increased variable load capacities in transit, operating and/or survival modes. Complete global and local structural analysis, stability analysis, mooring analysis, and motions analysis. Foundation designs for riser tensioners, APV bottles, P-Tanks, mooring winches, crane column, and crane boom rest. Lifeboat support structure and P-Tank support design. Design and analysis of riser rack and pipe rack areas, drill floor, derrick, and setback areas.

Engineering Projects

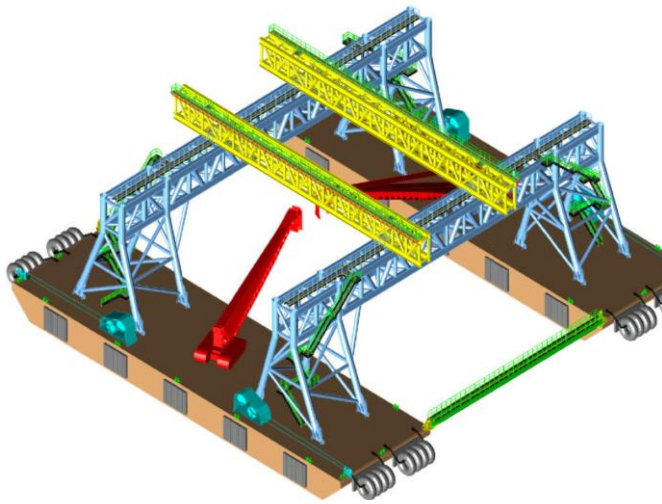

Catamaran Barge: Designed for various applications with up to 4 lifting lugs on the cross beams. Capacities up to 4000 Tons. Design and analysis of cross beams and the barges. Structural analysis, stability and ballasting, motions analysis, and mooring analysis.

Heavy Lift Crane Barge: Conversion of a dumb barge into a derrick barge with lifting capacity of 1600 Tons in revolving mode. Structural and Naval Architectural studies, Electrical and Mechanical systems design. Design of 102 man quarters.

Derrick/Pipelay Barge: On-site supervision of upgrades and conversion from jetting barge to a jetting/pipe-lay barge. This vessel is currently in operation in the GoM.

Shear-Leg Crane Barge: Used for bridge construction with a capacity to lift 2000 Tons at 130' radius. Lifting scenarios and ballasting calculations, boom structural analysis, and design of the new barge.

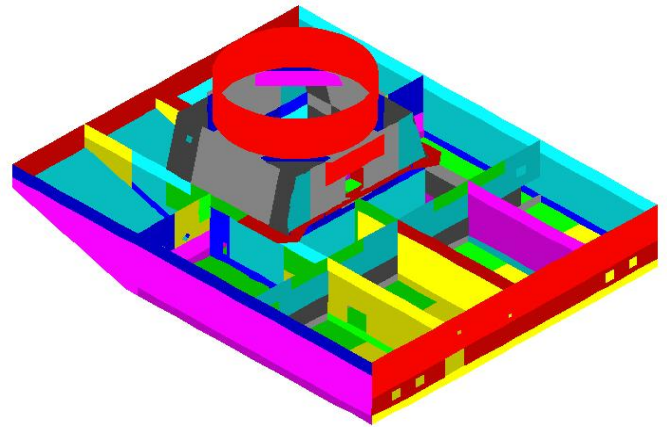

Harsh Environment Mooring System: A 32-point mooring system design for bridge caissons which were built in-situ, under the influence of up to 8 knot tidal current and 13 feet tidal variations. Assisted in model testing, developing the instrumentation system for real-time measurements, developed real-time mooring and motions monitoring system, and assisted in the field during the deployment of the mooring system.



SBIR: Improved Life Prediction of Turbine Engine Components, Phase I and II – included extension of 3D crack propagation analysis program based on FEM to include modeling of different types of cracks, effects of residual stress including contact effects, retardation, load spectrum, etc. The project was done under the supervision of US Air Force.

Deadweight Surveys and Incline Experiments: Performed deadweight surveys and incline experiments on several dozen vessels including mat-supported rigs, jackup rigs, barges, and semisubmersibles. Prepared survey procedure and performed the tests and provided submittals to classification societies for approval of lightship values.

Construction Supervision and On-site Assistance: Supervision and assistance provided for new builds, conversions and modifications of drilling rigs, production vessels, derrick/pipe-lay barges, offshore construction vessels, offshore support vessels, etc.

Engineering Software

The software development group at Zentech develops and markets the following state-of-the-art commercial software, primarily for Naval Architectural applications.

ZENMOOR MOORING ANALYSIS SOFTWARE FOR FLOATING VESSELS

ZenMoor is a Powerful State-of-the-Art, Windows-based program for Mooring Design and Analysis of Semisubmersibles, FPSOs, Spars, Barges, and other Floating Production Systems.

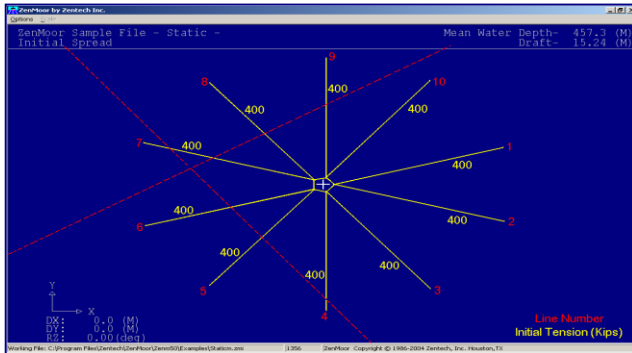

- Static, Quasi-Static and Dynamic Analysis
- Mooring Line Dynamic Analysis in Frequency and Time Domain
- Fatigue Analysis of Mooring Lines
- Vessel Relocation Analysis and Transient Motion Analysis
- Display of Pipelines, Pipeline Clearance, and Buoy Immersion Distances
- Database of Chain, Wire, and Anchor from Manufacturers
- Choice of Wave and Wind Spectra

NEPTUNE WAVE RADIATION AND DIFFRACTION ANALYSIS FOR LARGE FLOATING BODIES

Neptune analyzes structures ranging from a simple barge or caisson to a complex semisubmersible, TLP, or Floating Production System. Neptune employs a 3D constant panel radiation and diffraction analysis procedure to compute the hydrodynamic coefficients, motion RAOs, and wave drift loads.

- Graphical Interface for Model Generation
- Computation of Hydrodynamic Coefficients and Wave Loads
- Wave Frequency Motion Response and RAOs
- Mean Wave Drift Forces and Static Offset
- Slowly Varying Wave-Drift Forces and Damping Spectrum
- Regular and Random Waves
- Load Mapping to Structural Beam and Plate Elements

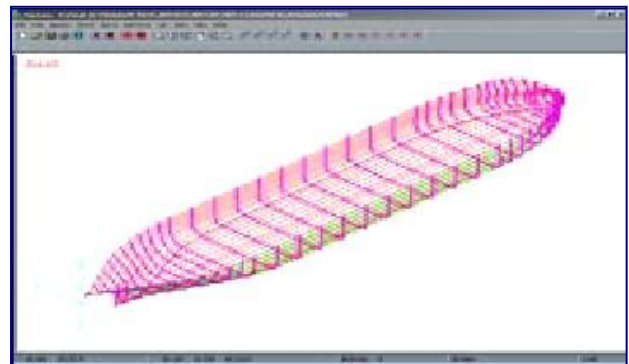

ZENMAP ONBOARD POSITIONING AND MOORING ADVISORY SOFTWARE

ZenMAP is a powerful State-of-the-art, rig-specific Mooring Advisory Program for use on Offshore Drilling Vessels, Floating Production Systems, and other Moored Vessels.

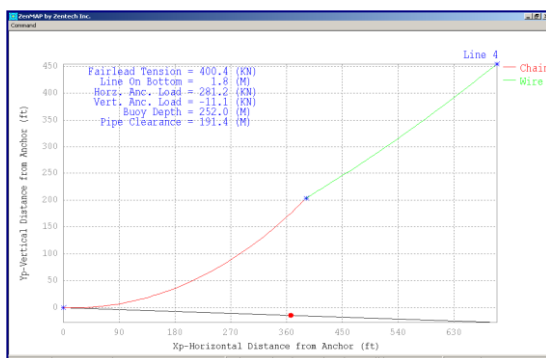

- Rig specific Mooring Advisory Program for all floating vessels
- Considers Influence of Thrusters, usage of Buoys and Clump Weights, Adding and Deleting Line Segments, Effect of Bottom Slope, etc.
- Good Graphic displays of the results along with line spread and profile
- Complete mooring analysis output parameters like line tension, vessel offset, pipeline clearance, anchor positions, relocation distance, etc., in graphic and text modes
- Static, Quasi-Static, and line break Transient Analysis

Engineering Software

LOSJACK ONBOARD LOAD AND STABILITY CALCULATOR FOR JACKUP RIGS

Part of Zentech's Suite of Load and Stability Calculating Programs, LosJack is an interactive, menu-driven, rig-specific software used in data management and loading calculations in the day-to-day operations of Jackup Rigs.

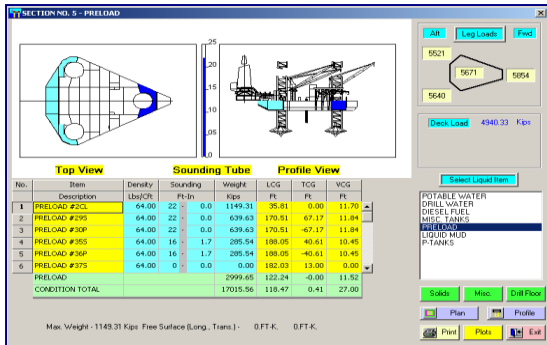

- Calculation of Liquid Weights and CGs from Tank Tables
- Calculation of Free Surface Moments in Each Tank and for the Complete Vessel
- Damaged Stability Calculations
- Leg Load and Soil Pressure Calculations
- Preload Schedule with Punch Through Calculations
- Comparison of Leg Penetration with Soil Properties
- Load Equalization Calculations
- Graphical Display of Rig, Weights, and Tanks

LOSEMI ONBOARD LOAD AND STABILITY CALCULATOR FOR SEMISUBMERSIBLES

Part of Zentech's Suite of Load and Stability Calculator Programs, LoSemi is an interactive, menu-driven, rig-specific software used in data management and loading calculations in the day-to-day operations of Semisubmersibles.

- Calculation of Liquid Weights and CGs from Tank Tables
- Calculation of Free Surface Moments in Each Tank and for the Complete Vessel
- Damaged Stability Calculations
- Interface with Mooring Advisory Software ZenMAP
- Large Angle Stability Calculations
- Performs Ballasting and Deballasting Procedures and Load Equalization Calculations
- Graphical Display of Rig, Weights, and Tanks

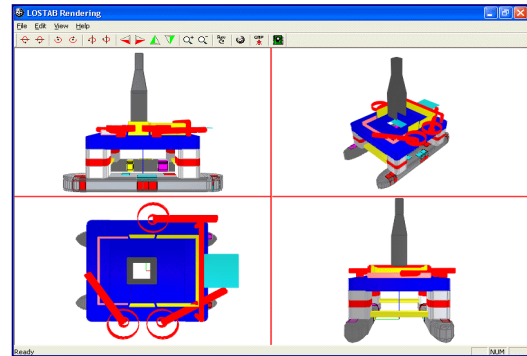

Z-RISER RIGID RISER ANALYSIS

Z-Riser is a 3D finite element analysis program for static, frequency domain, and time domain analysis of rigid drilling risers. Analysis can be performed on a riser in connected or disconnected configuration.

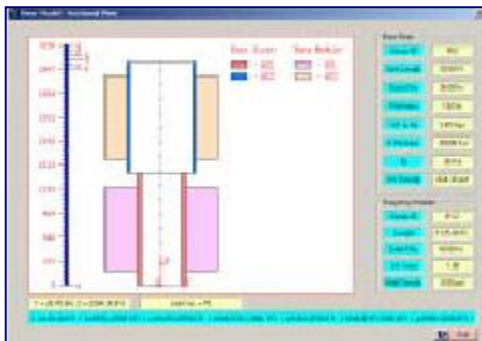

- Capable of geometric non-linear analysis with large displacements
- Finite elements include 3D Beam elements, Flex/Ball joints, Point Mass elements
- API RP 16Q code checks
- Displacement history for vessel motion and static offset
- Profile, Envelope, Dynamic History, Static Parametric Study, and Configuration plots available
- Nodal and Element Level variables
- Output includes top angle, bottom angle, bottom tension, Max. Von-Mises stress, Max. combined stress, and Slip Joint travel

For more information about the above programs, please contact Zentech.

For our consulting engineering work, Zentech uses all the above programs and Structural Engineering Analysis and Design Program **StruCAD*3D** and Stability Analysis Program **StabCAD**.

Partial Client List

GlobalSantaFe
Transocean Offshore
R. J. Brown & Associates
Nabors Offshore Corporation
Rowan Companies
R & B Falcon
Atwood Oceanics
Diamond Offshore Drilling
Cliffs Drilling Company
Shell Oil Company
Noble Drilling Corporation
ENSCO
BP Amoco
Brown & Root (U.K.)
Friede Goldman Offshore
Brown & Root (U.S.A.)
BHP Engineering & Construction
Sedco - Forex
Maersk Drilling
Chiles Offshore
Chevron Research & Technology
Phillips Petroleum
Conoco, Inc.
Paragon Engineering
Amoco
Transocean A.S.
Mobil Oil Research & Development
Oceaneering Prod. Systems
Technip Rauma Offshore OY
Oil & Natural Gas Corporation
Falcon Drilling Co., Inc.
Lamprell

Kerr-Mcgee Oil & Gas Onshore LLC
Pride International Inc.
Parker Drilling
Chiles Offshore LLC
Mitsubishi Heavy Industries
Exxon/Mobil Company
Freide Goldman
Willbros Engineers Inc.
Letourneau, Inc.
Massman Construction Co.
OASES Offshore, Inc.
Lloyd's Register Of Shipping
Schlumberger Technical Services, Inc.
Aban Lloyd Chiles Offshore Ltd.
Great Eastern Shipping Co. Ltd.
Damat Worley Engineering
Jurong Shipyard
Hyundai Mipo Dockyard Co., Ltd.
Aramco Services Company
Petro-Tech Peruana S.A.
National Drilling Company
Damus Limited
J. Ray McDermott Engineering, LLC
Pemex
Murphy Oil
Fluor Daniel, Inc.
J.P. Kenny
Dominion Exploration and Production
Tacoma Narrows Constructors
Kiewit Engineering Company
Kiewit / FCI / Manson - a Joint Venture

CONTACT US

Zentech, Inc.

14800 St. Mary's Lane, Suite 270
Houston, Texas 77079 USA
Tel: (281) 558-0290
Fax: (281) 558-0295
Email: zentech@zentech-usa.com

Zentech India Offshore & Marine Engineering Pvt. Ltd.

103/104 Building #5, Sector-2
Millennium Business Park, Mahape
Navi Mumbai 400701, INDIA
Tel: 91-22-27781416
Fax: 91-22-27781410
Email: zentech@zentech-usa.com

Zentech do Brasil Servicos Técnicos Ltda.

Av. Rio Branco 37, Gr. 1403, Rio de Janeiro,
RJ 20090-003
Tel: +55-21 2223-3310
Fax: +55-21 2283-3621
www.zentechbrasil.com
jracook@zentechbrasil.com

Zentech Mexico

Calle Pedro de Alvarado #68
Colonia Lomas de Cortes
Cuernavaca, Morelos
C.P. 62240, MEXICO
Tel: 52-777-101-8887
Email: zentech@zentech-usa.com

ZAIMS™ WORK FLOW

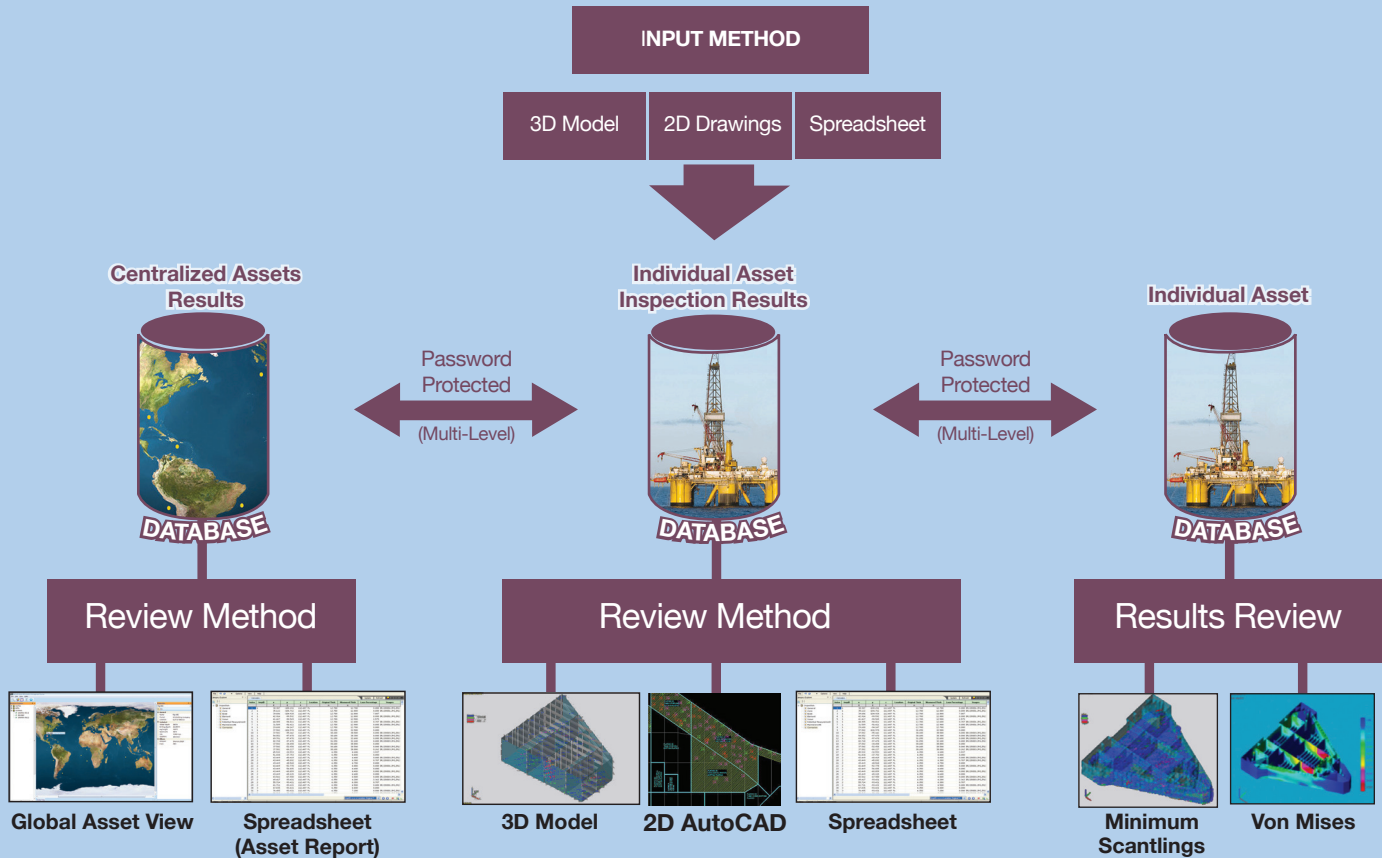

Manage Structural Integrity of Worldwide Assets

ZAIMS is a comprehensive tool that binds all the components into a seamless package for both individual assets and global fleet management.

The process uses an automated “assembly line” approach for bringing information into the ZAIMS database.

When Zentech is involved prior to the vessel inspection, template drawings are created in order that inspected

data can be directly entered into the 2D drawings and 3D model. This avoids the traditional “thousand page” report.

ZAIMS organizes and maintains reports and results of a single, as well as multiple inspections to record corrosion gauging, bends, dents, known cracks or steel replacement for each asset of the company in a single and securely accessible data repository.

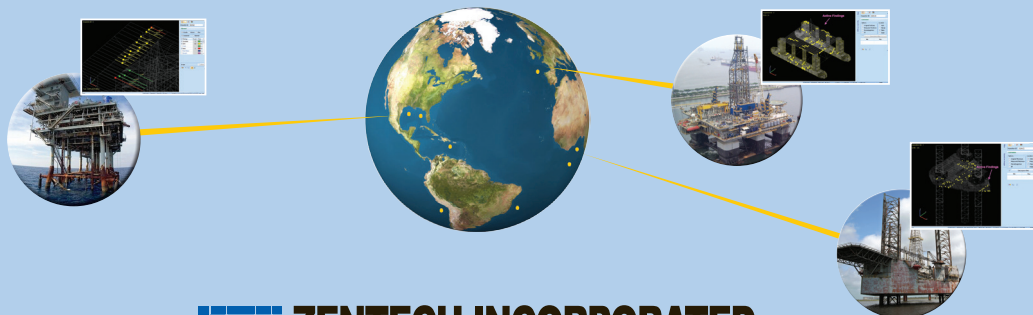

Traditional Asset Management Method...the Problem at Hand:



In the traditional vessel inspection/repair procedure, manual inspections are performed with corrosion data recorded in 2D sketches and spreadsheets.

Those sketches are then converted into various analysis models and summarized, and the results are brought into voluminous reports.

Field engineers, operations personnel and shipyard management are then confronted with all the information needed, but in a difficult-to-use format.

This "start-stop-start-stop" approach is not only laborious but also prone to human error and possible compromises to quality.

ZAIMS™ Methodology Streamlines the Procedure with Better Quality Control...

1. Zentech prepares AutoCAD template drawings, when possible.
2. Inspection Company adds gauged information in the drawings.
3. Gauged data is brought into the ZAIMS database from AutoCAD drawings.
4. The analysis model is built from the template drawings, using Zentech's patented procedure that converts 2D drawings into a 3D model.
5. Local minimum scantling and Global Von Mises are calculated, and the results are displayed in a 3D model, and also exported to the template drawings.
6. The field engineer and Class surveyor review the drawings and make final replacement decisions.
7. The fabricator can use the template drawings and continue the development of cut-sheets or fabrication drawings.

Item	Description	Select	Component	Quantity ft/ft ²
1	Area to be replaced	<input checked="" type="checkbox"/>	M	0
2	Area to be replaced	<input checked="" type="checkbox"/>	PL	5
3	Area to be replaced	<input checked="" type="checkbox"/>	PL	15
4	Area to be replaced	<input checked="" type="checkbox"/>	PL	7
5	Area to be replaced	<input checked="" type="checkbox"/>	PL	20
6	Area to be replaced	<input checked="" type="checkbox"/>	PL	33
7	Area to be replaced	<input checked="" type="checkbox"/>	PL	73
8	Area to be replaced	<input checked="" type="checkbox"/>	PL	1
9	Area to be replaced	<input checked="" type="checkbox"/>	PL	2
10	Area to be replaced	<input checked="" type="checkbox"/>	PL	2
Total				

Examples of ZAIMS™ 3D Model Output...

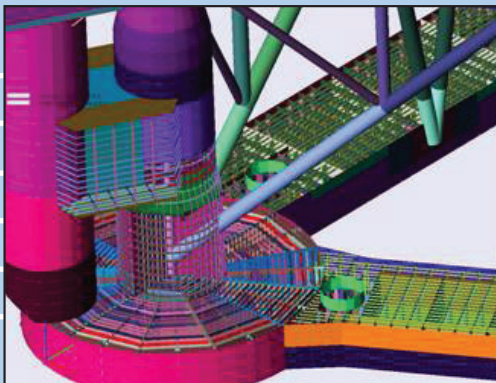

The 3D analysis model which is generated contains exact geometric and material perspectives.

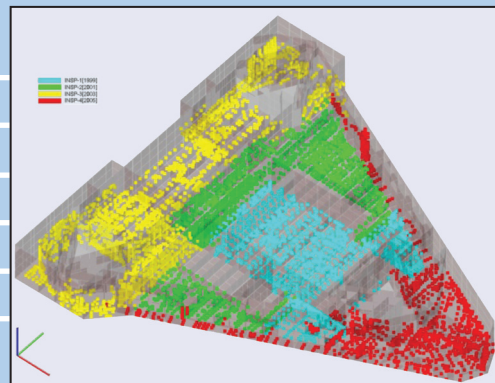

Corrosion points are plotted and segregated according to the inspected years and represented with various colors.

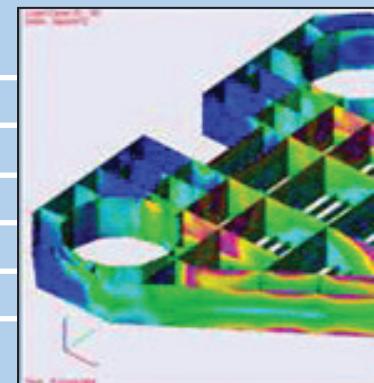

Stress analysis is performed for approved MOM criteria. Von Mises stress is displayed on the 3D model.

MTO (Material Take-Off)

Summary and detailed list of the quantity and cost for the selected material replacement areas are shown.

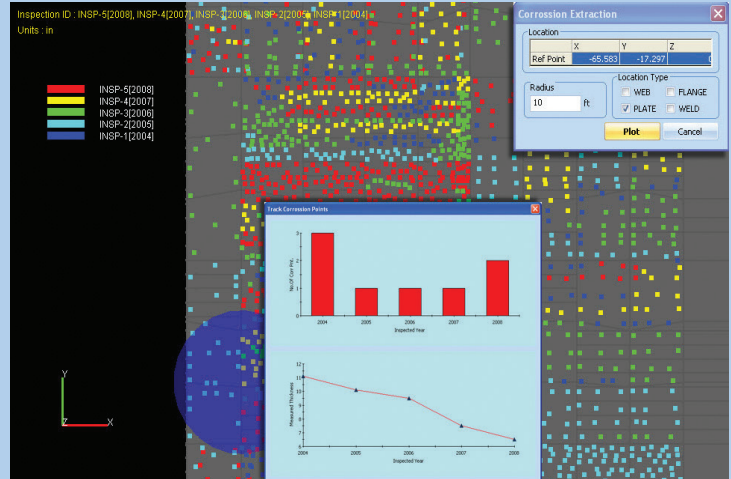
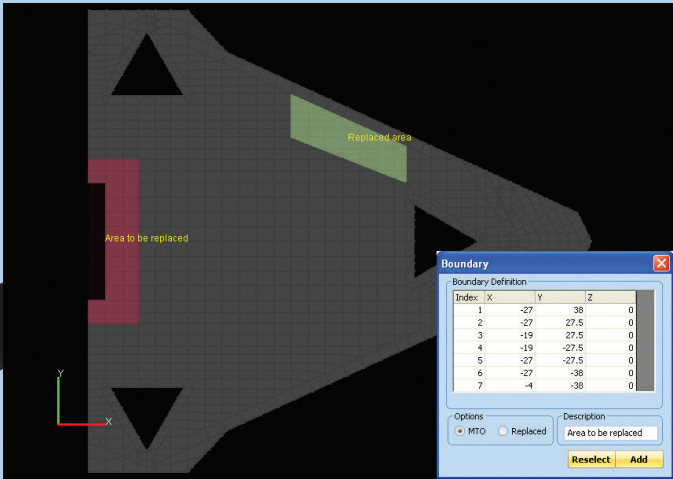

Recommended replacement and actual replaced areas can be defined directly in the 3D model. An MTO can be generated for these areas.

Variations in minimum measured thickness and the number of corrosion readings recorded in various inspections on a particular area can be plotted.

Specification	Section Type	Material	Weight kips	Cost USD per ton	Total Cost
9.68 24.00X18.00X1.00	BOK	50.00	8.61	\$10,000.00	\$39,053.55
4.30 0.320		34.00	0.32	\$10,000.00	\$1,460.60
3.82 0.340		34.00	0.97	\$10,000.00	\$4,396.67
4.84 0.360		34.00	0.03	\$10,000.00	\$146.35
7.67 0.380		34.00	0.95	\$10,000.00	\$2,481.32
8.39 0.400		34.00	1.55	\$10,000.00	\$7,040.89
11.50 0.420		34.00	2.58	\$10,000.00	\$11,704.45
7.65 0.438		34.00	6.31	\$10,000.00	\$28,601.05
5.05 0.460		34.00	0.13	\$10,000.00	\$581.85
3.43 0.480		34.00	0.26	\$10,000.00	\$1,187.58
21.31					\$96,654.32

Legend for thickness and stress values:

- Original thickness - 0.5 in
- Gauged thickness - 0.305 in
- Von Mises UC - 0.906
- Min scantling UC - 1.306

Point coordinates: (0.5, 0.305), 0.906, 1.306

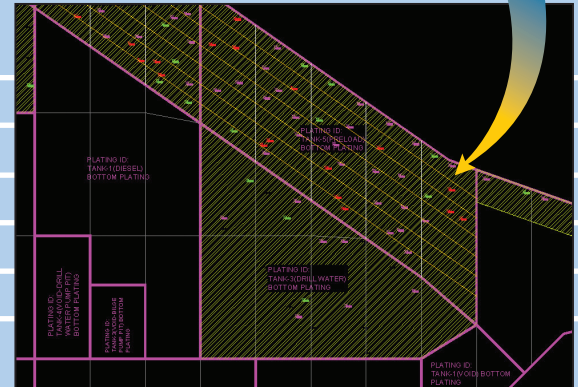
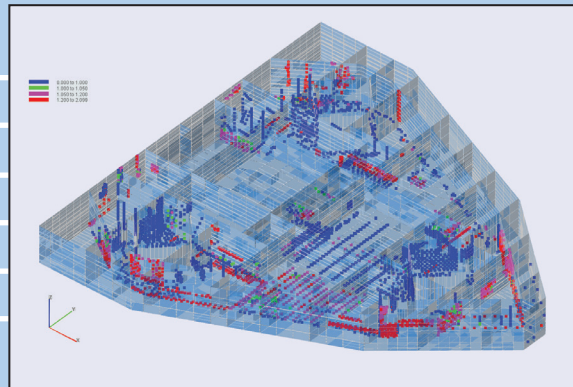
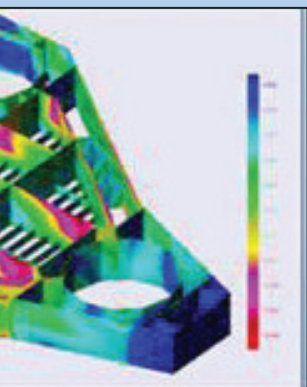

storm and drilling cases using stress contour plots are plotted on the

Class rules are used to determine the minimum scantling requirement for plates and stiffeners/girders for tanks and other compartments.

The recommended areas to be replaced are identified by the minimum scantling values and Von Mises stress rather than "15 percent loss" rules of thumb.

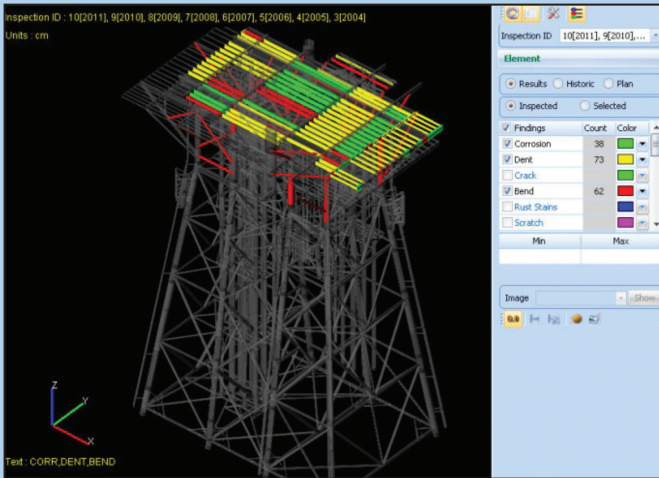

The information from Inspection Results is represented graphically in a 3D Model.

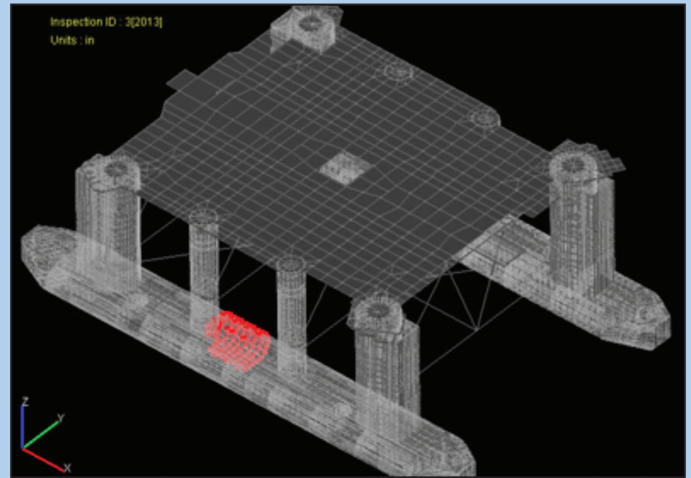

The Corrosion points can be filtered and viewed for an individual or multiple tanks of interests.

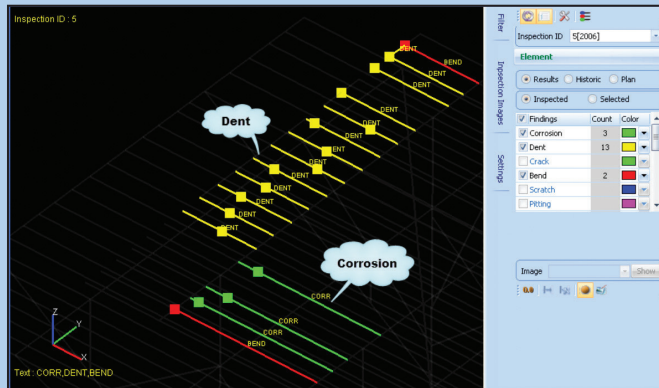

The elements with inspection data are highlighted in the model according to the findings.

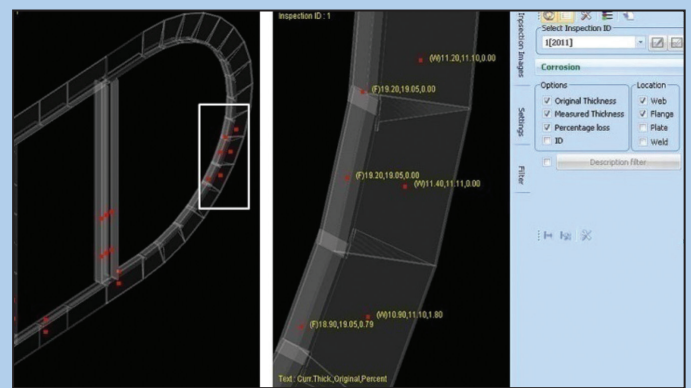

Thickness values (Original, Measured and Percentage loss) are highlighted in the locations (Web, Flange, Plate) of the model for each selected inspection ID or multiple IDs.

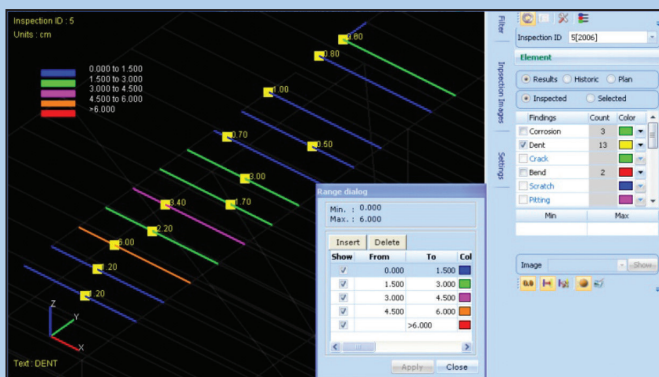

The values of the selected findings can be color coded based on the extent of damage.

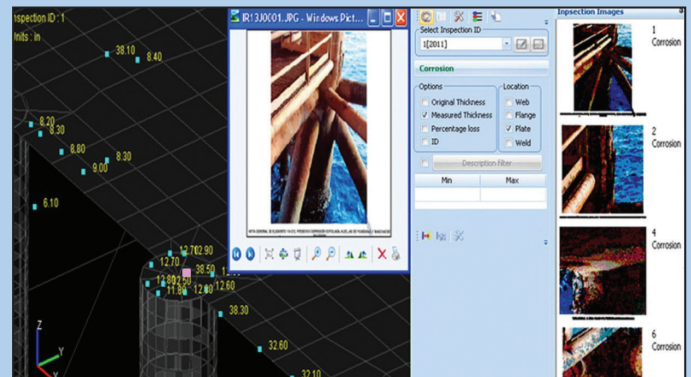

Photographs or video clips are posted for the selected inspection ID. The location is highlighted when an image is selected, and vice versa.

R-550D

Jack-up Drilling Rig

400 Ft. Water Depth (121.9m)
ABS Class Approved

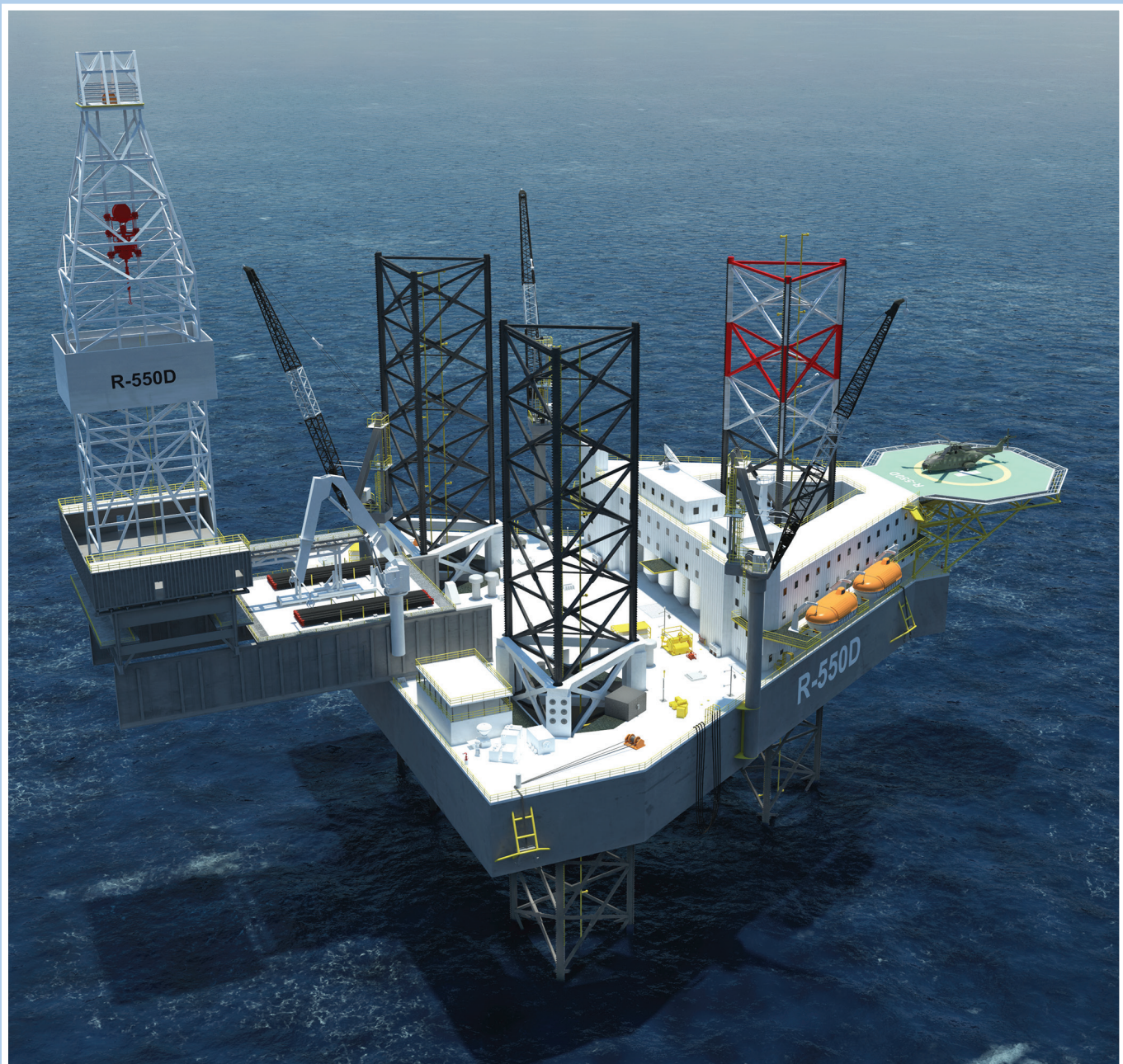

R-550D

R-550D Jackup Drilling Rig

- High-capacity and extended-reach cantilever rig, rated for 3,500 Kips combined drilling load (1,587mt) with extended reach to 80 Ft. aft of transom (24.4m).
- Operational Variable Deck Load 11,000 Kips (4,989mt).
- 4,220 barrel active/reserve mud pits (671m³) configured for dual fluid operations.
- Three mud pumps, each 2,220 HP TSC or equivalent (1,641 KW).
- Drill floor/cantilever, configured to off-line stand building with Iron Roughnecks.
- Living Quarters for 150-plus, with up to 11 office/conference/training rooms; configured to suit client needs.
- Utilities and drains configured for Zero Discharge.
- Base design for closed loop or air cooling of all equipment.
- High-speed preload system for minimized mobilization time.
- Superior jacking capacity with 54 pinions allows jacking with full preload (70,000 Kips / 31,746 mt), in addition to normal jacking of 54,000 Kips (24,490 mt).
- Footprint compatible with MLT-116; KFELS Mod V-B; JU-2000A.
- Drilling depth 30,000 Ft.+ (9,144m+).

HULL		
Hull Length	260 Ft.	79.2m
Hull Breadth	261 Ft.	79.6m
Hull Depth	27 Ft.	8.2m
Transit Draft	18 Ft.	5.48m
Transverse Leg Centers	142 Ft.	43.3m
Longitudinal Leg Centers	129 Ft.	39.3m

LEGS		
Triangular, open truss X-braced Legs		
3 Leg Configuration, Length	558.5 Ft.	170.2m
Spud Can Equivalent Diameter	54 Ft.	16.5m
Spud Can Maximum Bottom Bearing Pressure	8.39 Kips/Sq. Ft.	41.0mt/m ²

STORM SURVIVAL CRITERIA		
Water Depth	400 Ft.	121.9m
Air Gap	50 Ft.	15.24m
Wave Height	60 Ft.	18.3m
Period	15 Sec.	-
Surface Current	1.5 Knots	0.77 m/sec
Wind Velocity (1 Min.)	100 Knots	51 m/sec
Leg Penetration	25 Ft.	7.62m

JACKING AND FIXATION SYSTEMS	
Jacking:	TSC SJ1000 or equivalent
Fixation:	Zenlock™ System (Patented)

R-550D

STORAGE CAPACITIES		
Fuel Oil	4,033 bbls	641m ³
Potable Water	2,645 bbls	420m ³
Drill Water	23,078 bbls	3,669m ³
Preload	82,290 bbls	13,411m ³
Active Mud Tanks	4,220 bbls	671m ³
Mud Treatment Tanks	200 bbls	32m ³
Brine	1,222 bbls	194m ³
Base Oil	1,440 bbls	222m ³
Bulk Barite/Cement	13,500 Cu. Ft.	382m ³
Sack Storage	5,000 Sacks	
Main Deck Pipe Rack	500 Kips	227mt
Cantilever Pipe Rack	1,200 Kips	544mt

ACCOMMODATIONS	
Capacity to 150-Plus Persons	
Single, Double staterooms and up to 11 Office/Conference/Training Rooms to suit Client needs	

CLASSIFICATION, REGULATIONS	
<ul style="list-style-type: none"> As requested by Client: ABS MODU Code 2012 "Rules for Building and Classing Offshore Mobile Drilling Units," American Bureau of Shipping, 2012 Edition IMO, Modu Code 2009 Consolidated Edition International Convention of Loadlines, 1966 International Convention of Tonnage Measurements, 1969 MARPOL, 2011 Consolidated Edition ILO 92 & ILO133; International Labour Conference concerning Crew Accommodations on board Ship CAP 437 ABS CDS 2012 	

DRILLING EQUIPMENT		
Derrick	40 Ft. by 45 Ft. by 160 Ft.	12.2m by 13.7m by 48.8m
Hookload	1,500 Kips	680mt
AC Top Drive, TDS-8 or Equiv.	≤2,000 Kips	907mt
AC Drawworks	4,600 HP	3,430 KW
Mud Pumps	3 each 2,200 HP	1,641 KW
Mud Standpipes	7,500 psi	517 bar
Rotary Table	49.5 in.	1.26m
Diverter KFDJ Fixed (bore)	36.5 in.	0.927m
Choke & Kill	15,000 psi	1,034 bar
Knuckleboom Cantilever Crane	>2ST at 68 Ft.	>1.9mt at 21m

MUD TREATMENT	
Dual Fluid Active system	
2,400/1,500 GPM Solids Control System (9,085 / 5,678 lpm)	
Shaker House Located at Starboard Stern	
Permanent Flow Line	
Space and Utilities for Centrifuges	
Space and Utilities for Cuttings Equipment	
Bulk Tank Dust Collection System	
Bulk Transfer/Mud Mixing Control System	

POWER PLANT			
Main Power	5 each CatC175	2,586 bHP	1,929 KW each
Emergency Power	1 each Cat3512C	1,478 bHP	1,103 KW

CANTILEVER		
Longitudinal	80 Ft. Clear Aft	24.4m
Transverse	±20 Ft. Port / Starboard	± 6.1m
Combined Load Capacity	3,500 Kips	1,587mt
All Cantilever Utilities Routed in Permanent Drag Chains		

HELIDECK		
Helicopter	S61N, S92 or MI-8	
Dimensions	72.8 Ft. Octagon	22.2m
Deck type	Aluminum	

DECK CRANES		
3 Pedestal Cranes		
Port, Starboard & Aft Cranes	120 Ft. Boom Length	36.6m
Aft Crane Rating	110 Kips at 50 Ft. Radius	50mt at 15.2m
Port & Starboard Cranes Rating	154 Kips at 50 Ft Radius.	70mt at 15.2m Radius

PRELOADING EQUIPMENT		
2 Preload Pumps	4,500 gpm	17,034 lpm
2 Sea Water / Preload Pumps	2,200 gpm	8,328 lpm

FULL ZERO DISCHARGE CAPABILITY	
<ul style="list-style-type: none"> Space for Cuttings Collection or Treatment Oil-Water Separator for Drains and Bilge All Drains Routable to Collection / Storage All Equipment with Closed Loop Cooling 	

SERVICE TEMPERATURES		
For Steel: Service Temperature at	-4° F	-20° C
HVAC Ambient Range	-4° F to +122° F	-20° C to +50° C

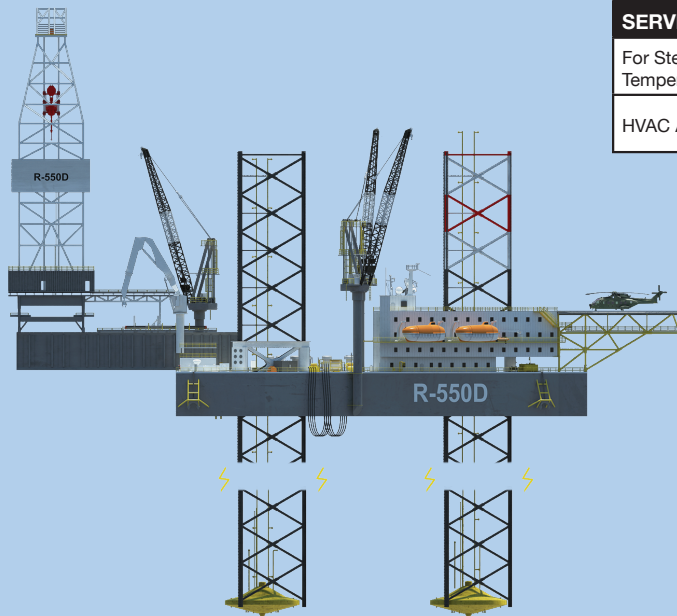

R-550D

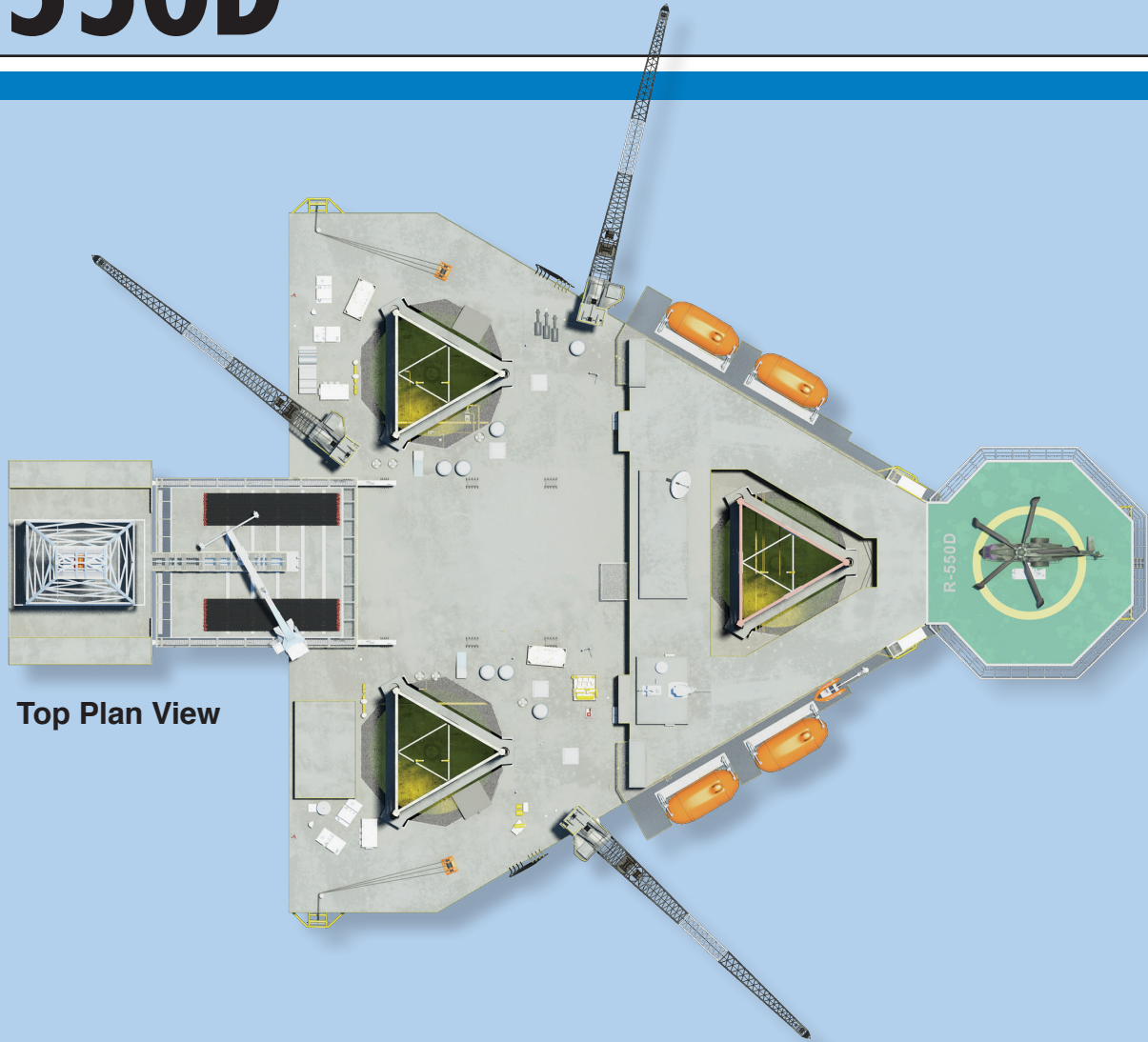

Top Plan View

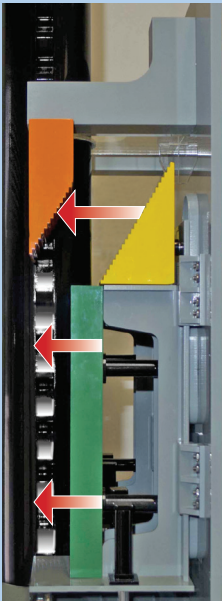

Zenlock disengaged

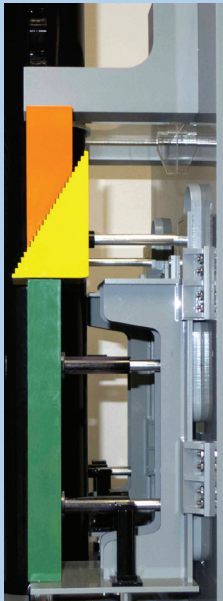

Zenlock engaged

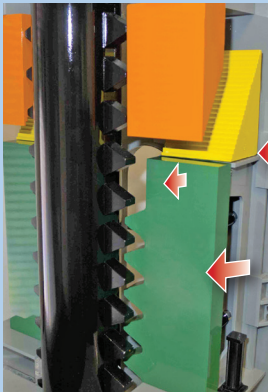

Zenlock disengaged



Zenlock engaged

ZENLOCK™ System

Zentech's patented ZENLOCK™ System provides unparalleled rig safety and ease of operation. This unique leg-to-hull fixation system has been designed, perfected and patented by Zentech engineers and is already under construction for the R-550D rigs being built for Alliance Offshore Drilling.

R-550D

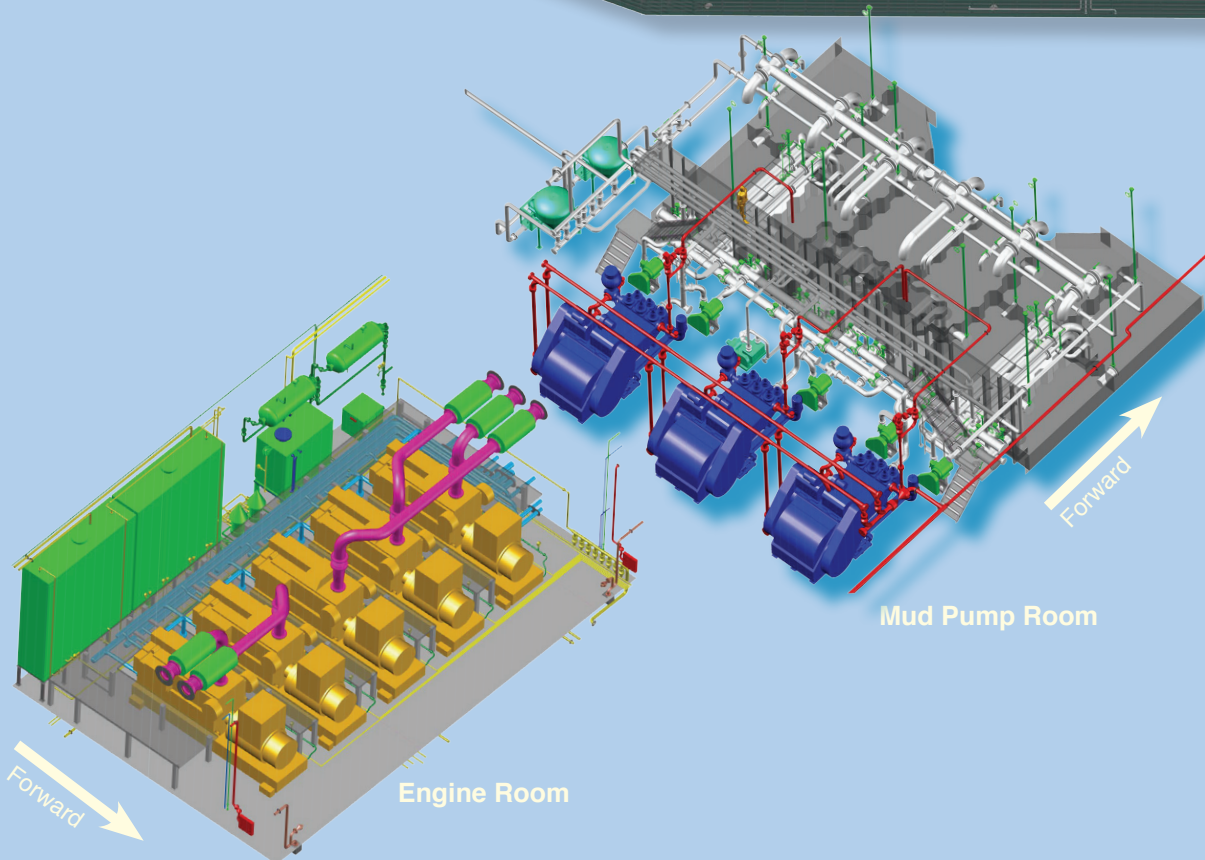
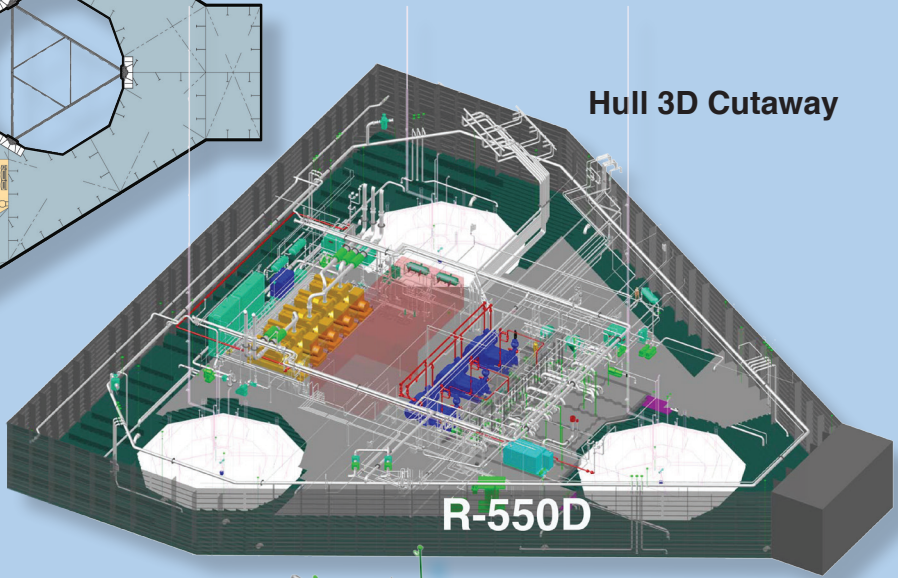
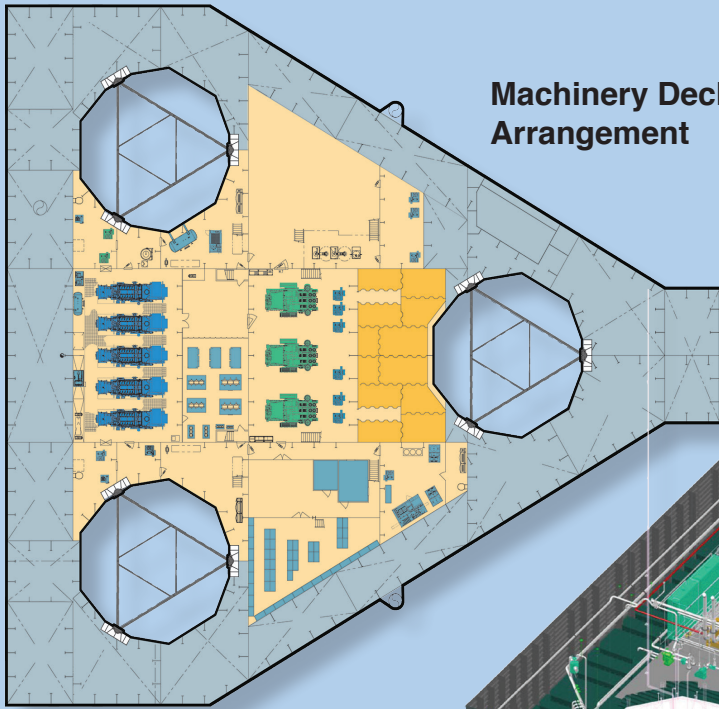

R-550D

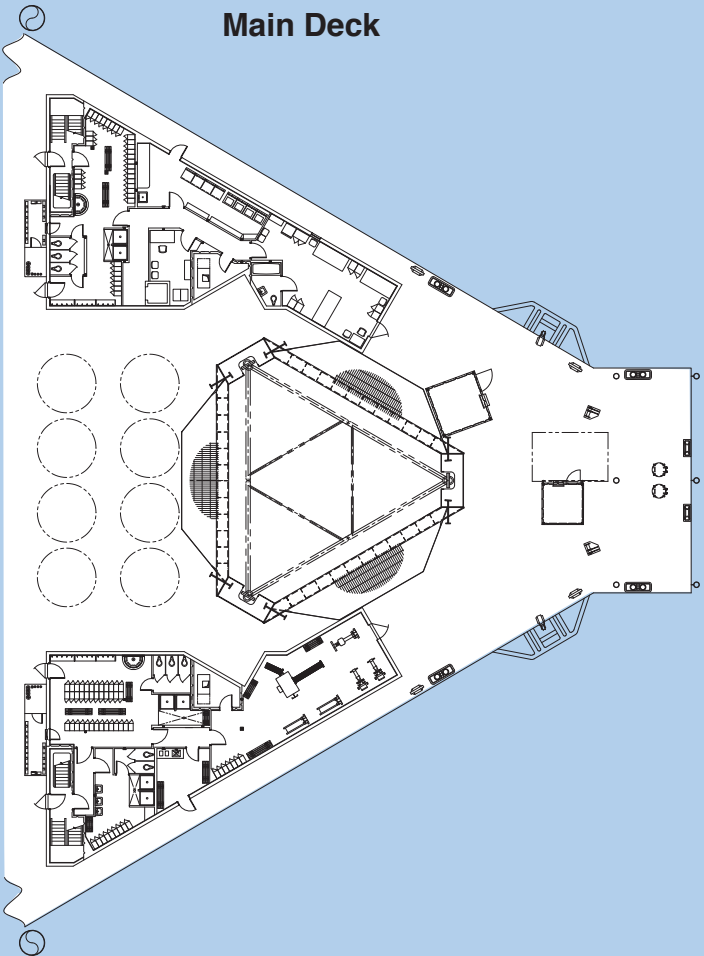

Main Deck

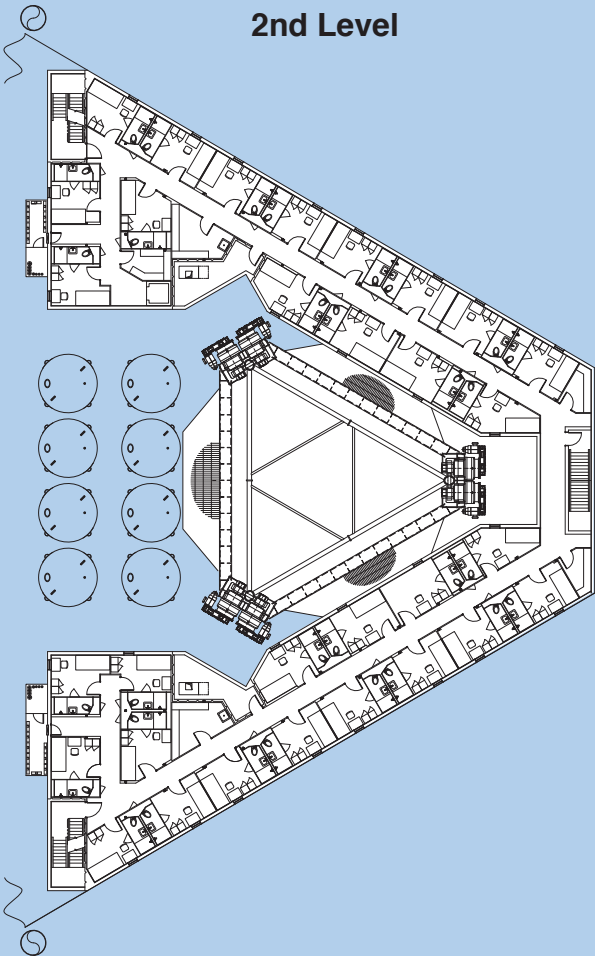

2nd Level

Level	1-Man Rooms	2-Man Rooms	Number of Men
1st Level (Main Deck)	0	0	0
2nd Level	0	31	62
3rd Level	0	24	48
4th Level	12	14	40
Helideck & Quarters Roof	0	0	0
Total	12 Rooms	69 Rooms	150 Men

R-550D

3rd Level

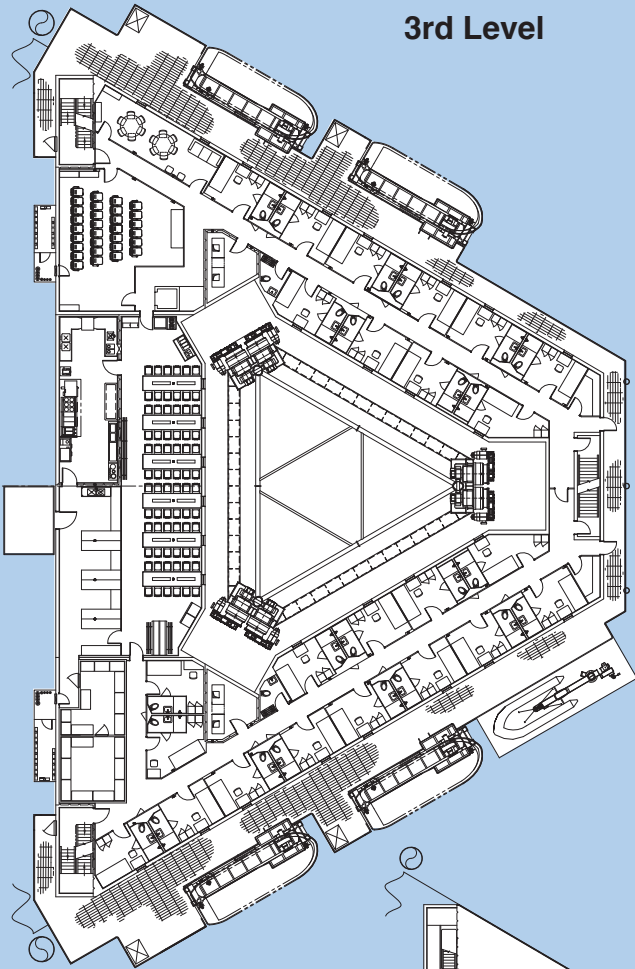

4th Level

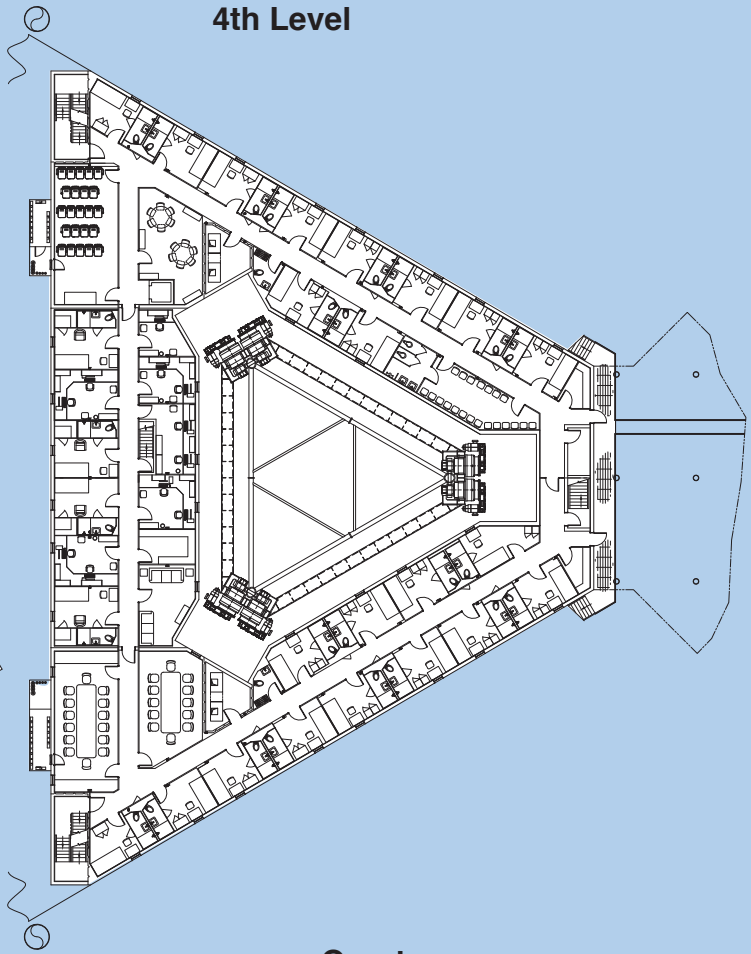

Quarters,
Roof & Helideck

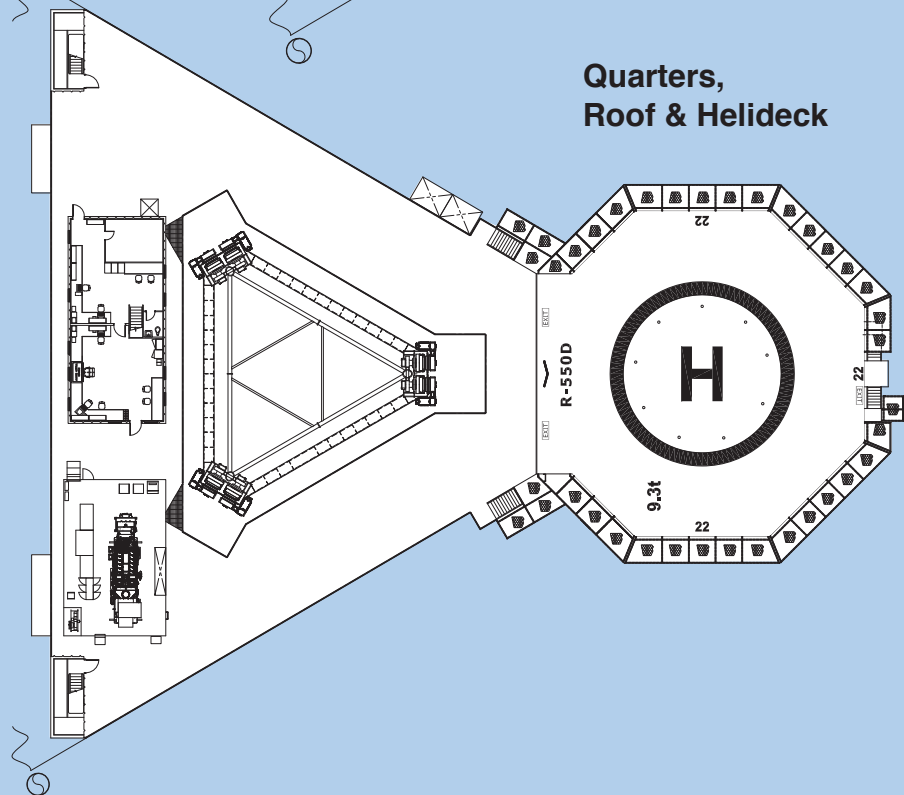

R-550D

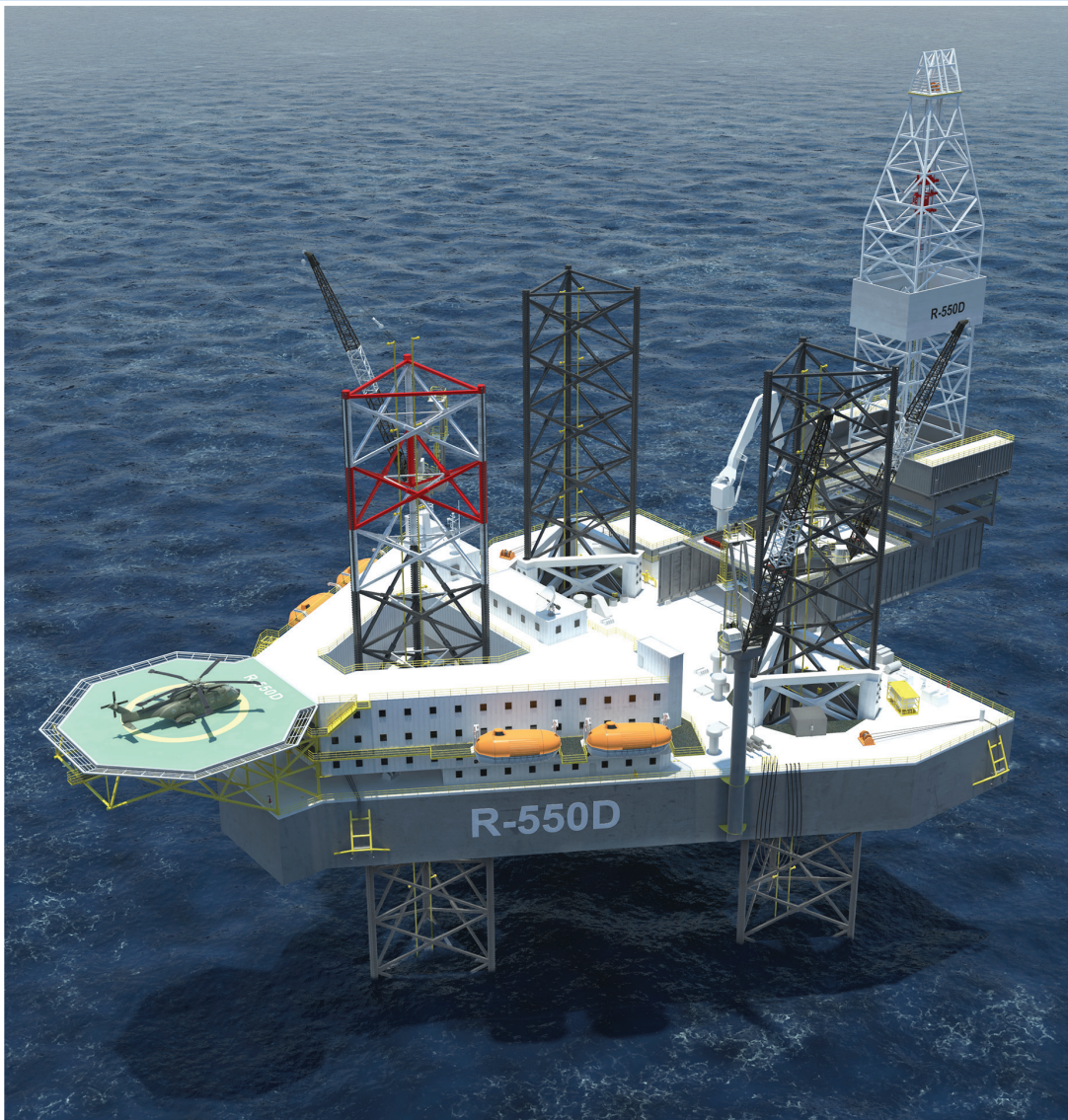

 **ZENTECH INCORPORATED**
INNOVATIVE ENGINEERING SOLUTIONS

14800 St. Mary's Lane, Suite 270
Houston, Texas 77079

Tel: +1 281 558 0290
Fax: +1 281 558 0295

E-mail: zentech@zentech-usa.com

www.zentech-usa.com

Z-636

500 Ft. Water Depth (152.4m)

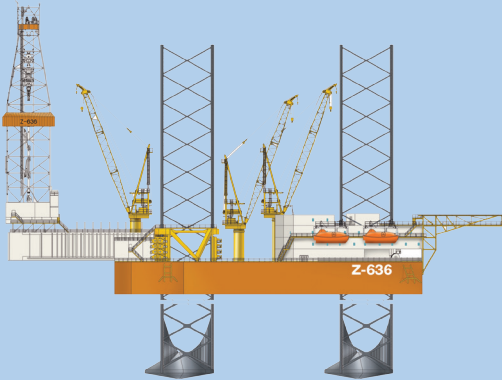
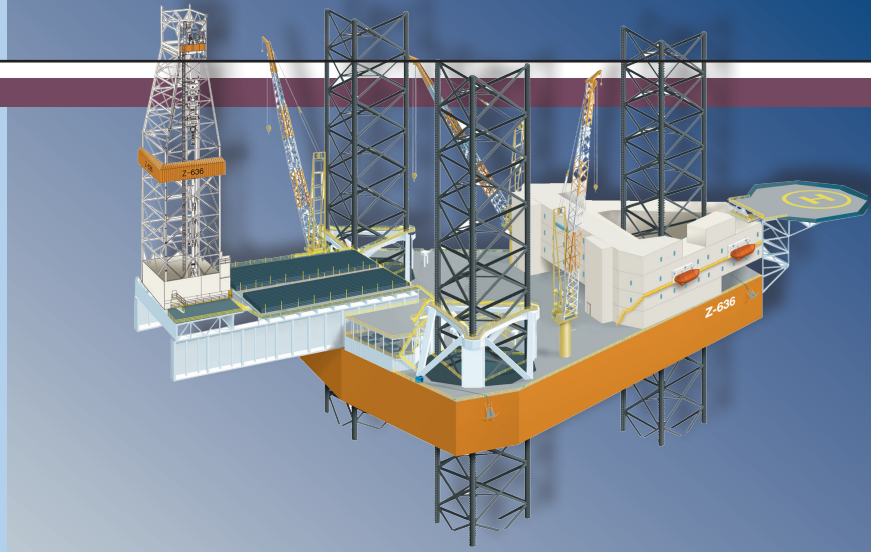

Zentech Z-636 Jackup Drilling Rig

- Extended reach, high-capacity cantilever rig, rated for 3,500 Kips combined drilling load (1,587.3mt).
- Operational variable deck load 18,000 Kips (8,163mt).
- 9,000 barrel active/reserve mud pits (1,431m³) configured for dual fluid operations.
- Four mud pumps, each 2,200 HP (1,641 KW).
- Drill floor/cantilever equipped for mechanized pipe racking, configured for easy upgrade to off-line stand building and hands-free pipe handling from pipe rack to well center.
- Living Quarters for 150-plus, with up to 11 office/conference/safety training/helicopter waiting rooms; configured to suit client needs.
- Very large deck area to enable multiple operations offshore.
- Large under deck rooms for extensive storage capacity.
- Utilities and drains configured for Zero Discharge.
- Base design for closed loop or air cooling for all equipment.
- High-speed preload system for minimized mobilization time.

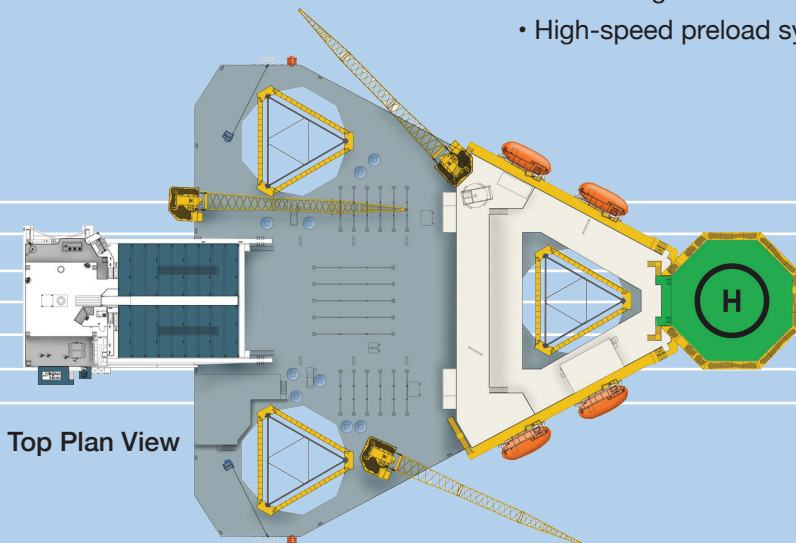

Top Plan View

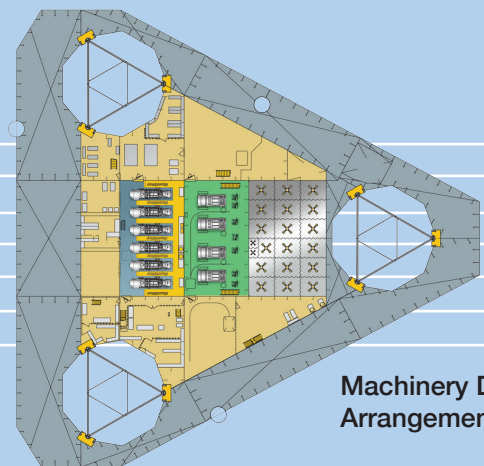

Machinery Deck Arrangement

Z-636

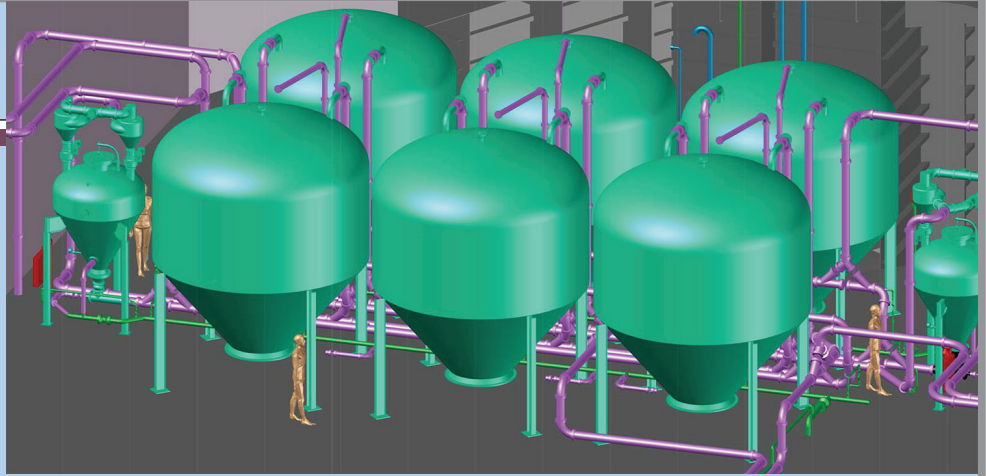

3D model of main deck P-Tanks.

HULL

Hull Length	287 Ft.	87.5m
Hull Breadth	284 Ft.	86.6m
Hull Depth	30 Ft.	9.2m
Transit Draft	16 Ft.	4.7m
Transverse Leg Centers	192 Ft.	58.6m
Longitudinal Leg Centers	167 Ft.	51.0m

LEGS

Triangular, open truss X-braced Legs

3 Leg Configuration, Length	636 Ft.	193.9m
Spud Can Equivalent Diameter	61 Ft. 9 In.	18.8m
Spud Can Maximum Bottom Bearing Pressure	8.39 Kips/Sq. Ft.	41.0mt/m ²

JACKING AND FIXATION SYSTEMS

Jacking: 1,000 Kips per pinion (45.4mt)

Fixation: Zenlock™ System (Patented)

STORAGE CAPACITIES

Fuel Oil	6,921 bbls	1,100m ³
Potable Water	3,658 bbls	582m ³
Drill Water	34,124 bbls	5,426m ³
Preload	117,604 bbls	18,699m ³
Active Mud Tanks	9,000 bbls	1,431m ³
Mud Treatment Tanks	812 bbls	129m ³
Brine	700 bbls	111m ³
Base Oil	700 bbls	111m ³
Bulk Barite/Cement	18,000 Cu. Ft.	508m ³
Sack Storage	5,000 Sacks	
Main Deck Pipe Rack	500 Kips	227mt
Cantilever Pipe Rack	1,200 Kips	544mt

ACCOMMODATIONS

Capacity to 150-Plus Persons

Single, double staterooms and office/conference/training rooms to suit client needs.

POWER PLANT

Main Power	6 each CatC175	2,586 bHP	1,929 KW each Diesel Driven Generators
Emergency Power	1 each Cat3512C	1,478 bHP	1,103 KW Diesel Driven Generator VFD Control System

DRILLING EQUIPMENT

Drilling Depth	30,000 Ft.+	9,144m+
Derrick	40 Ft. by 40 Ft. by 200 Ft.	12.19m by 12.19m by 61m
Operating Variable Deck Load	18,000 kips	8,163mt
Hookload	2,000 Kips	907mt
AC Top Drive	2,000 Kips	907mt
AC Drawworks	4,500 HP	3,357 kW
Mud Pumps	4 each 2,200 HP	1,641 kW
Mud Standpipes	7,500 psi	517 bar
Rotary Table	49.5 in.	1.3m
BOP	18.75 in., 15,000 psi	0.48m, 1,034 bar
Integral diverter	49.5 in.	1.3m
Choke & Kill	15,000 psi	1,034 bar

- BOP Handling for 2 Stacks
- BOP Test Stump (Easily upgradeable to include offline Standbuilding and/or hands-free pipe handling from piperack to well center)
- Mechanized Piperacking system
- Enclosed Driller's House
- Automated Control System

MUD TREATMENT

Dual Fluid Active system
2,400/1,500 GPM Solids Control System (9,085 / 5,678 lpm)
Shaker House Located at Starboard Stern
Permanent Flow Line
Space and Utilities for Centrifuges
Space and Utilities for Cuttings Equipment
Bulk Tank Dust Collection System
Bulk Transfer/Mud Mixing Control System

CANTILEVER

Longitudinal	80 Ft. Clear Aft	24.4m
Transverse	±20 Ft. Port / Starboard	± 6.1m
Combined Load Capacity	3,500 Kips	1,587mt
All Cantilever Utilities Routed in Permanent Drag Chains		

HELIDECK

Helicopter	S61N, S92	
Deck type	Octagon, Aluminum	

DECK EQUIPMENT

3 Pedestal Cranes		
All Cranes	120 Ft. Boom Length	36.6m
All Cranes Rated	>50 ST at 60 Ft. Radius	>45mt at 15.2m
Dedicated Preload Pump	6,000 gpm	22,712 lpm
2 Preload Pumps	4,500 gpm	17,034 lpm
2 Sea Water / Preload Pumps	2,200 gpm	8,328 lpm

FULL ZERO DISCHARGE CAPABILITY

- Oil-Water Separator for Drains and Bilge
- All Drains Routable to Collection / Storage
- Base design for closed loop or air cooling for all equipment.

SERVICE TEMPERATURES

For Steel: Service Temperature at	-4° F	-20° C
HVAC Ambient Range	-4° F to 134° F	-20° C to +53° C

CLASSIFICATION, REGULATIONS

Latest ABS or DNV MODU Code

Z-210

210 Ft. Water Depth (64m) Self-Propelled Jackup Multi-Purpose Service Jackup

- DP-II Ready
- Four 1,500 HP Azimuthing Thrusters
- Variable Load 5,000 Kips
- Main Deck:
 - 18,000 Sq. Ft. Working Area
 - 1,000 PSF Load Capacity
- Bow-mounted Helideck Rated for Sikorsky S-61N, S-92 per CAP-437
- Variations Available

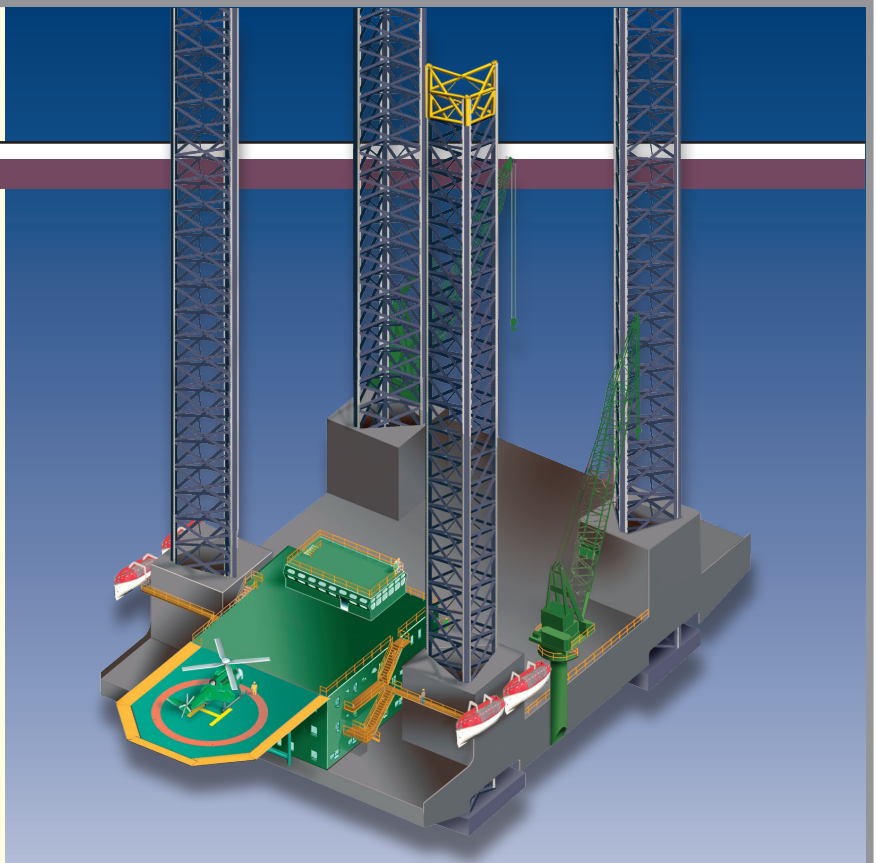

Key Dimensions

Description	U.S.	Metric
Hull Length	224 ft.	68.3m
Hull Breadth	144 ft.	43.9m
Hull Depth	20 ft.	6.1m
Inner Bottom Depth	4 ft.	1.2m
Longitudinal Leg Centers	112 ft.	34.1m
Transverse Leg Centers	112 ft.	34.1m
Aft Leg Centers to Stern	48 ft.	14.6m
Leg Length	321 ft.	97.8m
Leg Chord Spacing	24 ft.	7.3m
Rack Thickness	5 in.	127mm
Spud Tank	31'-6" x 31'-6" x 5'-6"	9.6m x 9.6m x 1.7m

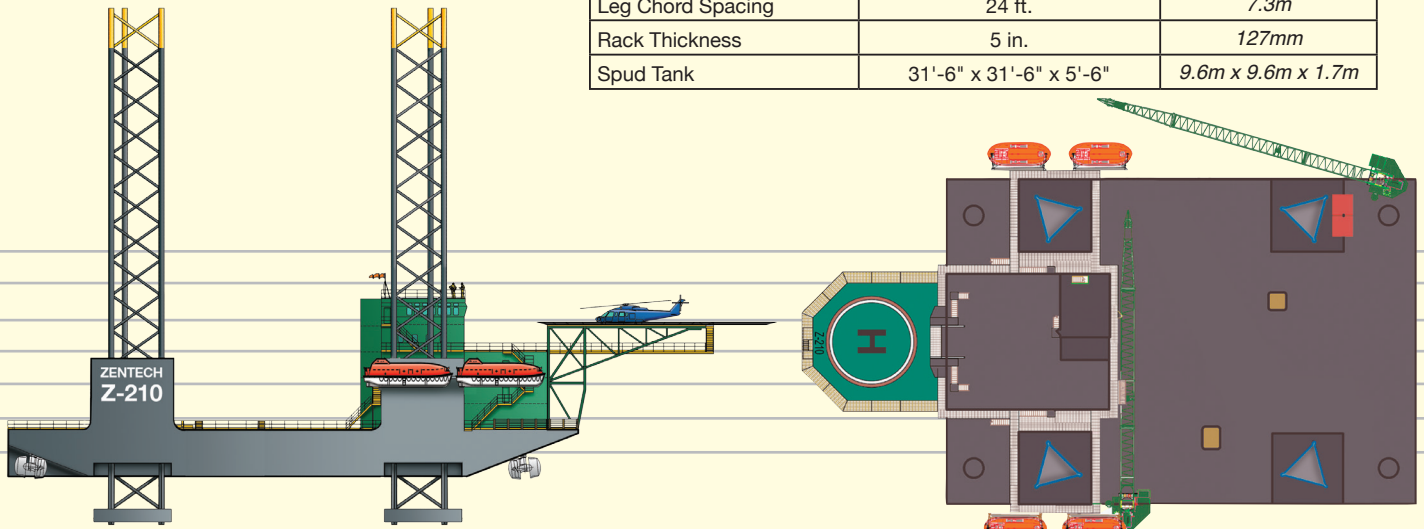

Z-210

**210 Ft. Water Depth (64m)
Self-Propelled Jackup
Multi-Purpose Service Jackup**

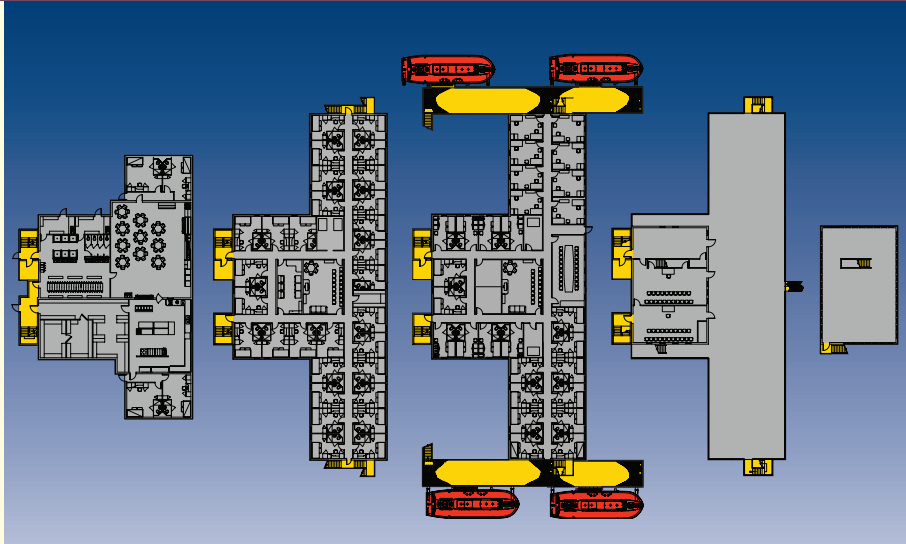

Quarters Arrangement for 100 in 2-Person Rooms

Regulatory

- ABS A-1 Self-Elevating Unit
- USCG Certified
- Designed to IMO MODU
- Units can be designed to meet requirements of other regulatory/certification authorities as needed

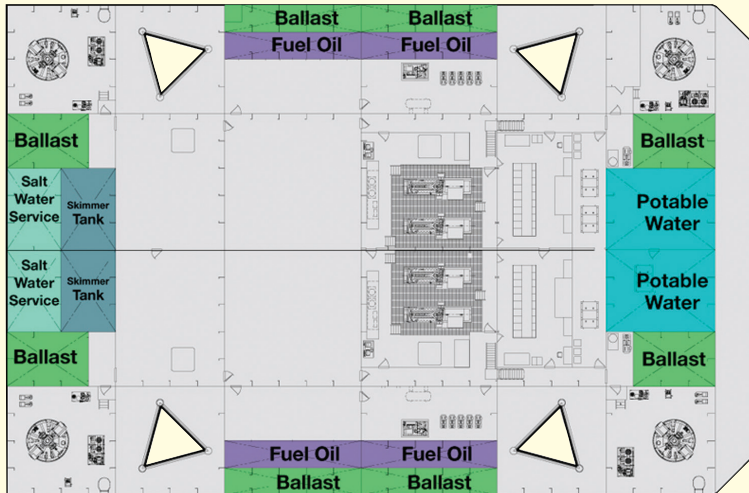

Nominal Tank Capacities

- Fuel.....6,256 bbls.
- Ballast8,952 bbls.
- Potable Water4,360 bbls.
- Salt Water Service1,854 bbls.
- Waste Water.....1,440 bbls.
- Skimmer Tank1,440 bbls.
- Fresh Water.....8,044 bbls.

Z-210-WF

Offshore Wind Farm Installation and Service Vessel

- Rated for up to 210 Ft. (64.0m) Water Depth; Deeper water depth variations available
- Self-Propelled and DP-II
- Four Azimuthing Thrusters
- Variable Load 11,600 Kips (5,261mt)
- Sized for 10 Complete Wind Turbines, Towers and Blades
- Cantilever-mounted Main Crane
- Jacking Speed 5 Feet Per Minute (1.5mpm)
- Berthing for 80 persons (Marine and Client)
- Helideck rated for Sikorsky S-61, S-92 per CAP-437

Main Crane

Cantilever-mounted 550 U.S. ton capacity (500mt) with 380 Ft. telescoping boom (116m). Conventional booms are available.

Working Lift:

US: 386 tons at 82 Ft. Radius, 295 Ft. Vertical Hook Height

Metric: 350mt at 25m Radius, 90m Vertical Hook Height

Utility Crane

25 U.S. ton capacity (22.7mt) with 50 ft. (15.2m) boom.

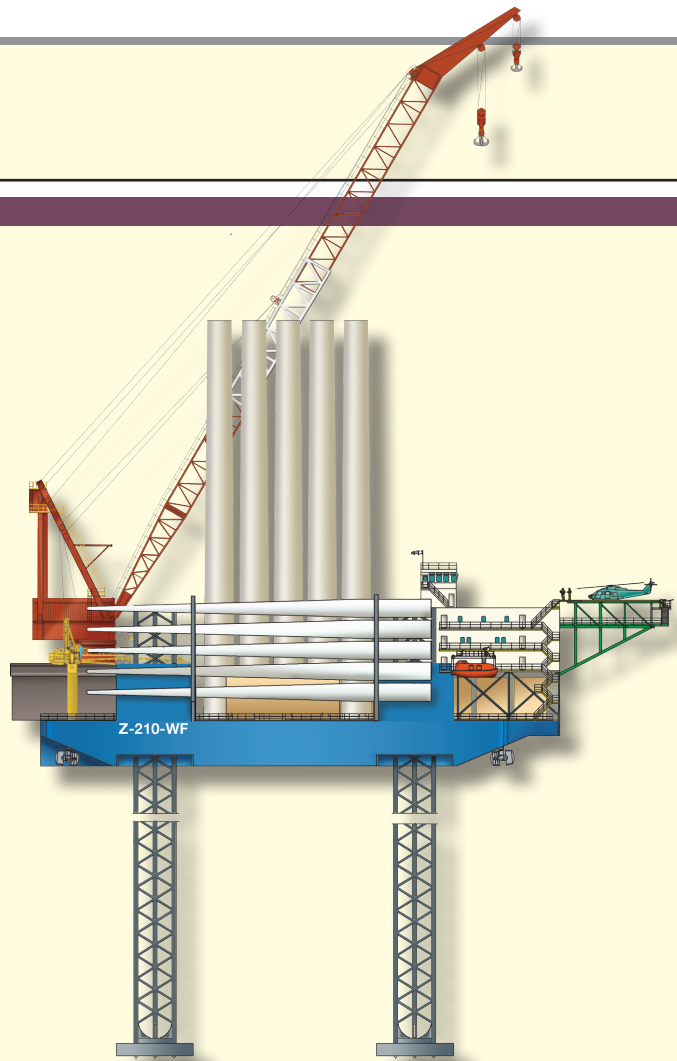

Key Dimensions	US	Metric
Hull Length	272 Ft.	82.9m
Hull Breadth	174 Ft.	53.0m
Hull Depth	24 Ft.	7.3m
Hull Draft	16 Ft.	4.9m
Leg Length	325 Ft.	99.0m
Leg Chord Spacing	24 Ft.	7.3m
Service Speed Knots	9 Knots	9 Knots

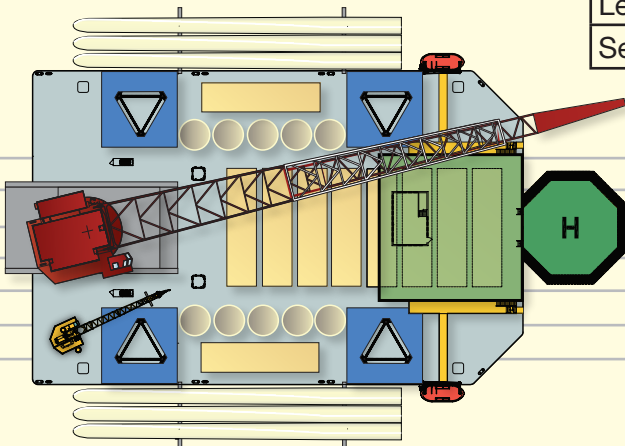

Top view of main deck showing 10 complete sets of wind turbine components; 4 turbine nacelles are stored beneath the quarters' complex. Crane boom is shown retracted for transit.

Z-210-WF

Offshore Wind Farm Installation and Service Vessel

Quarters Arrangement

- 80 persons (Marine crew and client staff)
- 38 two-person staterooms with shared bathroom facilities
- 4 single person staterooms with private bathroom facilities
- Office and conference room facilities
- Welfare and recreation facilities

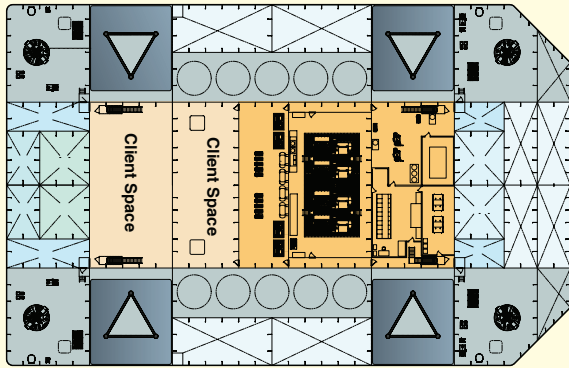

Machinery deck arrangement

Regulatory

- ABS Class, A-1 Self-Elevating Unit
- USCG Certified
- Designed to IMO MODU, SOLAS
- U.S. Flag, Jones Act compliant
- Units can be designed to meet requirements of other regulatory/certification authorities as needed

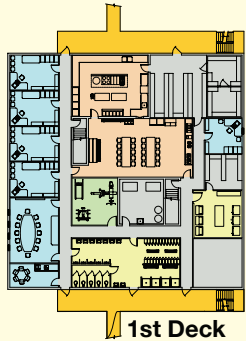

1st Deck

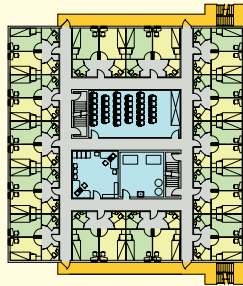

2nd Deck

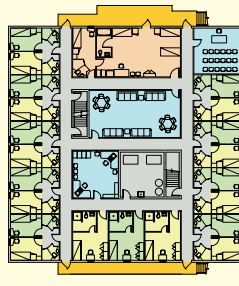

3rd Deck

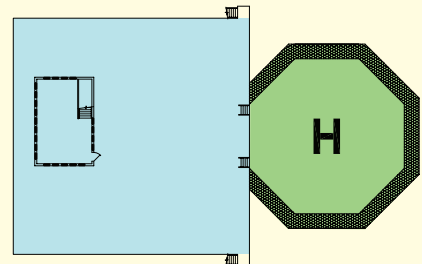

Roof/Pilot House

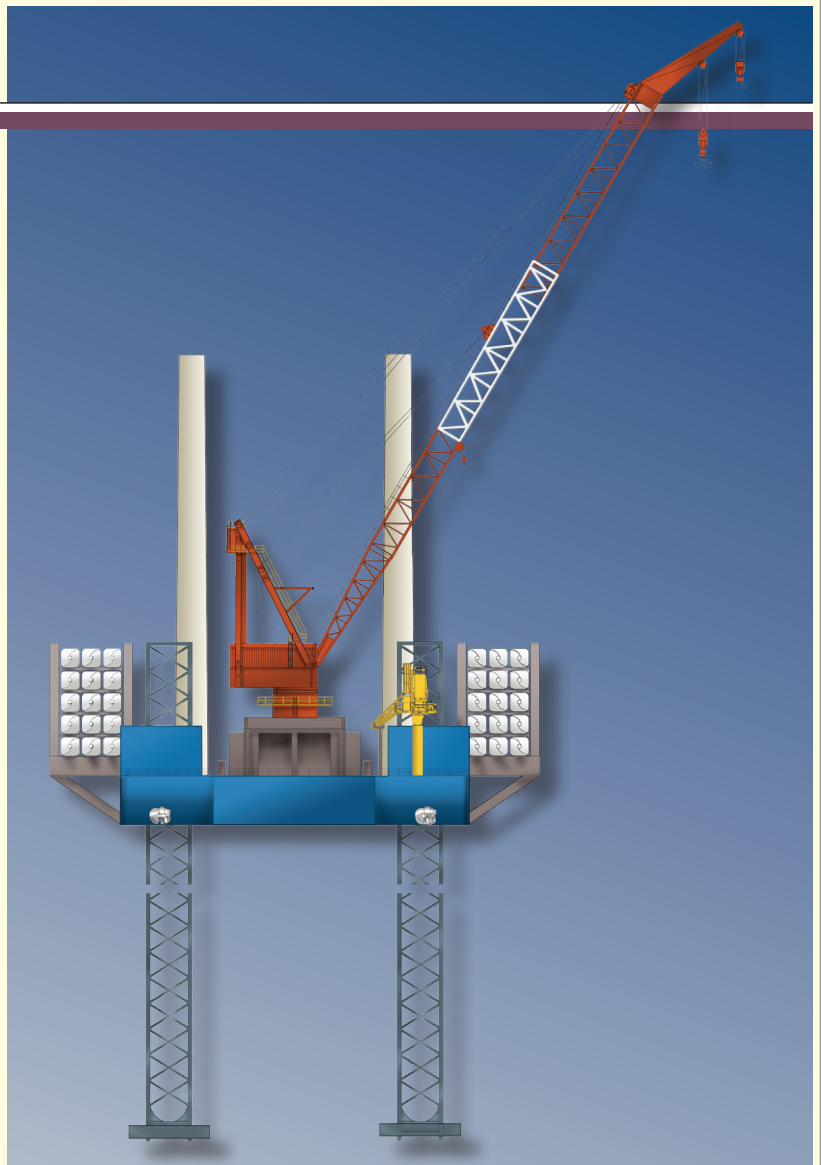

Propulsion

- Self-Propelled and DP-II
- Equipped with 4 each 2,500 HP 360-degree Azimuthing Thrusters with VFD Drive Systems
- Equipped with either 4 or 6 Propulsion Diesel Generators

 **ZENTECH INCORPORATED**
INNOVATIVE ENGINEERING SOLUTIONS

14800 St. Mary's Lane, Suite 270
Houston, Texas 77079

Tel: +1 281 558 0290
Fax: +1 281 558 0295

E-mail: zentech@zentech-usa.com www.zentech-usa.com

Semi-Submersibles & Drillships

Semi-Submersibles



NOBLE Paul Wolff

- Conversion from Submersible to DP Semi-Submersible



- Feasibility Study
- Stability Analysis
- Motion Response
- Mooring Analysis
- Riser Analysis
- Options studied for Increased VDL
 - Column Blisters
 - Increased Column Diameter
 - Additional Column

ZENTECH Ultra-Deepwater Design Super EVA

- DP-III Capable
- 40,000 Ft. Drilling Depth
- Dual Functionality on Drill Floor
- 12,000 Ft. WD

NOBLE Semi-Submersibles

- Feasibility Study, Basic Design & Complete Detail Design
- 10,000 Ft. WD
- DP-II Class Rigs
- Shipyard Support Team
- Project Management



NOBLE Dave Beard
(Shelf Class)



NOBLE Jim Day
(Bingo Class)



NOBLE Danny Adkins
(Bingo Class)



Diamond Offshore Ocean Confidence

- Conversion from Accommodations to Drilling Unit
- Construction Drawings
- Riser gantry crane support, deck superstructures
- Drill floor modifications
- Piping systems
- Moon pool addition
- ROV handling structures
- BOP handling support structure

Additional Zentech Clients include: Atwood Oceanics, Statoil (Petrobras), Japan Drilling Co., Marine Drilling, Pride, Viking Offshore, Moss Maritime

ZENTECH INCORPORATED
INNOVATIVE ENGINEERING SOLUTIONS

Semi-Submersibles & Drillships

Drillships



NOBLE Roger Eason

- Conversion to DP-II Class Drillship for Petrobras Contract
 - Feasibility Study
 - Basic and Detailed Design to Shipyard
 - Design Engineering to Remove and Replace:
 - Stern Section
 - Bow Section
 - Add Port and Starboard Sponsons
- Complete Conversion Engineering

Global Santa Fe Robert F. Bauer

- Upgrade for Deeper Water Depth
 - Study for Upgrade
 - Substructure Analysis
 - Helideck Design
 - Casing Rack Analysis
 - Weight Calculations



ONGC (Oil and Natural Gas Companies, Ltd.) Sagar Shushan

- Mooring Analysis for Drillship
- Quasi-Static and Dynamic Analysis for:
 - Intact
 - Damage
 - Mooring Analysis
 - Transient Conditions
- Water Depths of 1,300 ft. to 3,000 ft.

MODULAR PLATFORM DRILLING RIGS

Offshore Packages

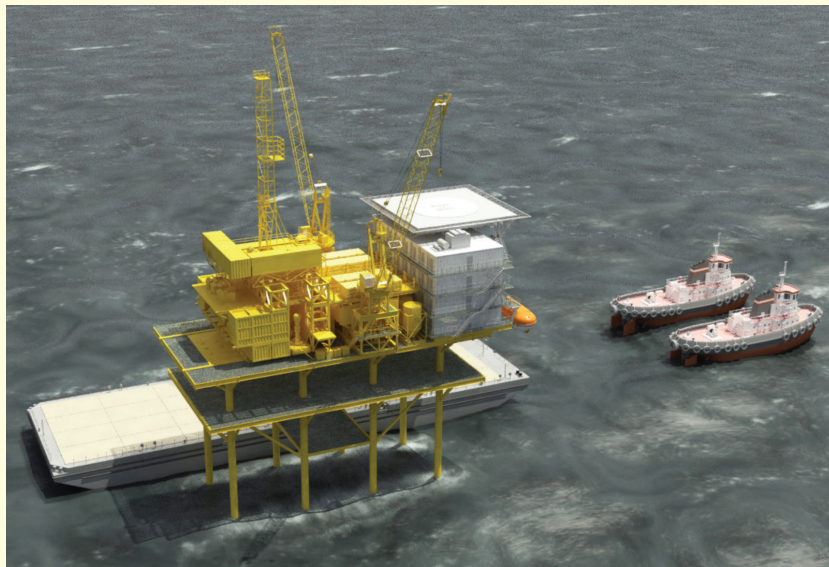

Conceptual view of rig upon completion of self-erecting process.

Contact Zentech for full technical specifications and video animation of this design's self-erecting capability.

3,000 H. P. Modular Drilling Rig Lightweight and Self-Erecting

- Self erecting offshore drilling rig
- Self erecting mast, 1,500,000 Lbs. capacity (680.3mt)
- Active and reserve mud pits 1,750 barrel capacity (278m³)
- 3 mud pumps of 2,200 HP (1,641kW)
- Drill floor equipped for mechanized pipe racking
- Living quarters consisting of 32 Modules and 112 person total occupancy:
 - Twenty-five 4-person Rooms
 - Six 2-person rooms
 - 2 offices
 - Control room, conference rooms, helicopter waiting/safety training room, TV/recreation rooms, sick bay, gym, galley, dining room, change room—per client requirement
- Utilities and drains configured for Zero Discharge: all equipment closed loop or air cooled
- High capacity drilling systems
- Drill floor configured for safe, efficient drilling operations

Sequence summary of unique self-erecting capability

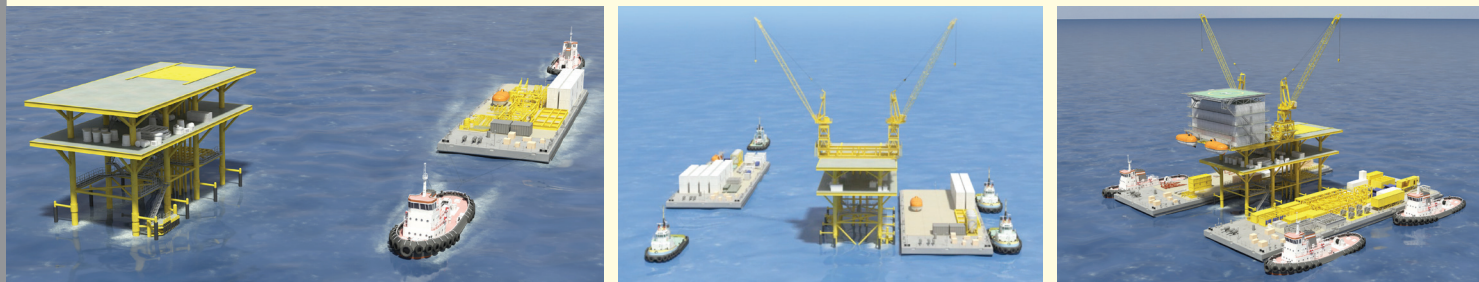

Platform components arrive via 4 towed barges. Erection of rig can be completed without the need for a crane barge.

MODULAR PLATFORM DRILLING RIGS

Onshore Packages



AADU (Alaskan Arctic Drilling Units) 1,800 HP Rigs enroute to Prudhoe Bay, Alaska by Parker Drilling.

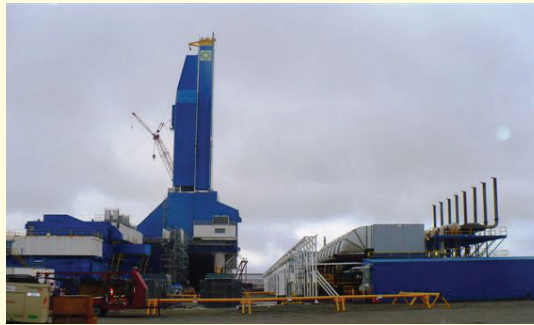

Liberty rigs being readied to work for BP.



AADU rigs on location in Prudhoe Bay, Alaska.

Land Rig Design

Lightweight and Self-Erecting



- Helicopter Drilling Rig for Parker Drilling Company
- Mud System and Mud Pits
- Mast and substructure design for a number of land rigs
- Converted land rigs to platform rigs for Nabors International
- Design of mast for a number of land rigs
- Design of mast for NOV (ex Dreco) for earthquake zone
- Design a new land rig for Grey Wolff Drilling Company (now Precision Drilling)
- Design a new land rig for WZ Industries

Engineering Projects

Nabors Offshore Platforms

- Sundowner X
- Sundowner XI
- Super Sundowner XII
- Super Sundowner XVII
- Amoco Trinidad
- Sundowner 240K Rig
- Nabors 269
- Sundowner Rig 801
- Sundowner Rig 802
- Sundowner Rig 803

Design Projects

Pool Company Offshore Platforms

- Amoco Trinidad
- Pool Rig 489



14800 St. Mary's Lane, Suite 270
Houston, Texas 77079

Tel: +1 281 558 0290
Fax: +1 281 558 0295

E-mail: zentech@zentech-usa.com www.zentech-usa.com

ZEE RIG 1

Small Waterplane Area Twin Hull

- Ultra-stable vessel
- Length 237 Ft., Breadth 95 Ft.
Length 72.2 m, Breadth 29.0 m
- Top Deck Open Space 15,000 Ft.² (1,400 m²)
- Below Deck Open Space 16,500 Ft.² (1,550m²)
- Sea-keeping and motion characteristics up to Sea State 5
- Self-propelled and DP (DP-II capable upon request)
- Available for Charter within 6-9 months
- Located in Green Cove Springs, Florida
- Bare-deck will be configured to client requirements
- U.S. Flag Vessel, Jones Act compliant



Zee Rig 1 configured as 300 person Floating Hotel.

Zentech is the owner of Zee Rig 1, a Semi-SWATH technology vessel that is approximately 75% complete and in a bare-deck configuration. The vessel is berthed in Houston, Texas where it is undergoing outfitting. Zentech owns the design rights to this vessel and the related family of Semi-SWATH units.

Zentech is a Houston-based marine engineering and naval architecture consulting firm specializing in the offshore oil and gas and renewable energy industries.

The company has a thirty year history of providing innovative engineering solutions, and employs a professional staff of over 160 in six international locations. Zentech also owns five state-of-the-art drilling rig jackup and wind farm support vessel diagrams.

Ideally suited for:

- Offshore wind farm maintenance and service work
- Floating hotel • General offshore service support
- Sub-sea ROV or dive support work
- Commuter or shuttle passenger service



Zee Rig 1 in ROV Support configuration.

ZEE RIG 1

Small Waterplane Area Twin Hull

SWATH Background

SWATH concept vessels have been used for many years in oceanographic research applications because of their superior stability characteristics. More recently, they have been used for offshore vessel crew changes and similar applications. The North Sea is now using SWATH vessels for harbor pilot transport due to their improved motion characteristics. The use and application of SWATH vessels is expected to grow due to their motion keeping advantages.

ZEE RIG 1 is a Semi-SWATH design that avoids the operational limitations of more conventional SWATH vessels, which typically have a circular pontoon cross section and deep draft. The Semi-SWATH design employs a variable draft concept with a more rectangular pontoon cross section. This variability allows for matching draft to sea conditions and more efficient transits in favorable weather with the pontoons only partially submerged, and providing steadier operation at slower speeds in heavy seas with the pontoons fully submerged. The rectangular pontoon cross section greatly reduces the amount of vessel motion in a seaway when operating fully submerged at slow speeds or holding station.

The ZEE RIG 1, by virtue of its Semi-SWATH design, exhibits a minimum of vessel rolling or pitching. Propulsion is by twin screws (one propeller in each pontoon) and bow thruster for ease of maneuvering. The vessel may be outfitted with DP-II upon request. The vessel employs dynamic positioning. It is ABS Class and SOLAS compliant.



Zee Rig 1 in Wind Farm Servicing configuration.

Key Dimensions	U.S.	Metric
Length, overall	237 Ft.	72.2 m
Length of pontoons	225 Ft.	68.6 m
Breadth overall	95 Ft.	29.0 m
Breadth-pontoons	24 Ft.	7.3 m
Upper hull depth	13 Ft.	4.0 m
Depth to main deck	46 Ft.	14.0 m
Draft at design waterline	21.5 Ft.	6.6 m
Minimum draft	12.5 Ft.	3.8 m
Lightship displacement	1,570 L. Tons	1,595 mt
Loadline displacement	3,446 L. Tons	3,400 mt
Approximate deck load capacity	200 L. Tons	203 mt
Propulsion on each shaft	1,500 HP	1,200 kw
Emergency generator	350 KW	350 kw
Fuel capacity (95%)	38,265 US Gal.	144,849 l
Fresh water capacity (95%)	37,265 US Gal.	141,063 l
Service speed transit draft	12 Knots	12 knots
Service speed at loadline draft	9-10 Knots	9-10 knots



Vessel prior to outfitting.

 **ZENTECH INCORPORATED**
INNOVATIVE ENGINEERING SOLUTIONS

14800 St. Mary's Lane, Suite 270
Houston, Texas 77079

Tel: +1 281 558 0290
Fax: +1 281 558 0295

E-mail: zentech@zentech-usa.com www.zentech-usa.com

ZEE RIG 3

Offshore Wind Farm Installation Vessel

- Available for Charter
- Rated for up to 61m water depth; options to 76.2m
- 64m distance from hull bottom to top of spud can (spud can height 9.1m)
- Self-propelled, DP-II
- Variable load 4,990mt
- Net variable load 4,800mt
- Sized for 10 Complete Wind Turbines: Towers, Nacelles and Blades
- Jacking speed 0.46mpm
- Berthing for 45 persons (Marine and Client) to meet North Sea requirements
- Additional facilities available below deck
- Helideck rated for Sikorsky S-61, S-92 per CAP-437

Main Crane

AmClyde Model 52 marine crane, currently rated 680mt with 83.8m boom (70m to main fall). Crane may be upgraded to 1,000mt.

Working Lift:

680mt at 22.9m Radius, 71.0m Vertical Hook Height

Starboard Utility Crane

45.4mt with 36.6m boom

Port Utility Crane

136.1mt with 36.6m boom

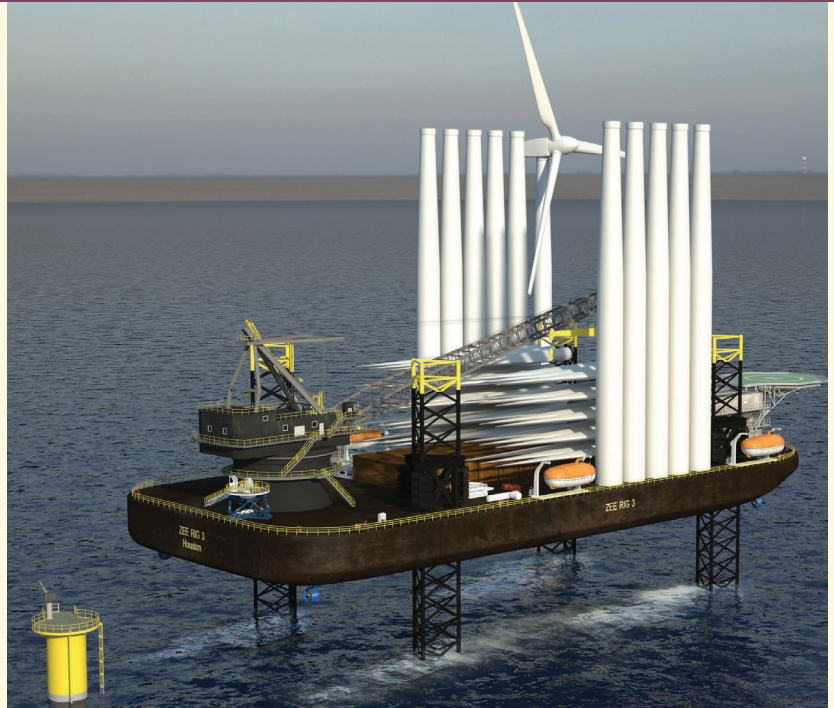

Key Dimensions:	US	Metric
Hull Length	400 ft.	121.9m
Hull Breadth	210 ft.	64.0m
Hull Depth	29 ft.	8.8m
Hull Draft	18 ft.	5.5m
Leg Length	315 ft.	96.0m
Leg Chord Spacing	42 ft.	12.8m
Service Speed Knots	8 Knots	8 Knots

Zentech is the owner of ZEE RIG 3, currently undergoing conversion from a marine crane barge to an offshore wind farm installation vessel and or crane barge. ZEE RIG 3 is also ideally suited for platform removal and other oil and gas duties. The vessel is available for charter. Please contact us now for additional details.

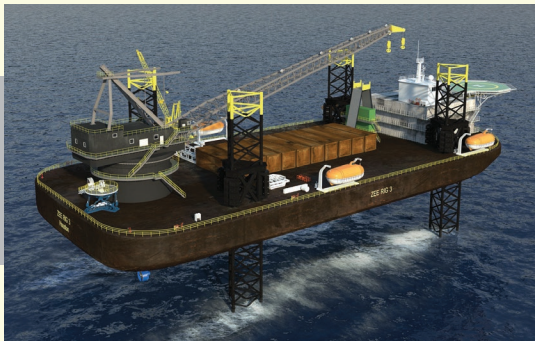

Zee Rig 3 outfitted as a self-propelled heavy-lift crane vessel.

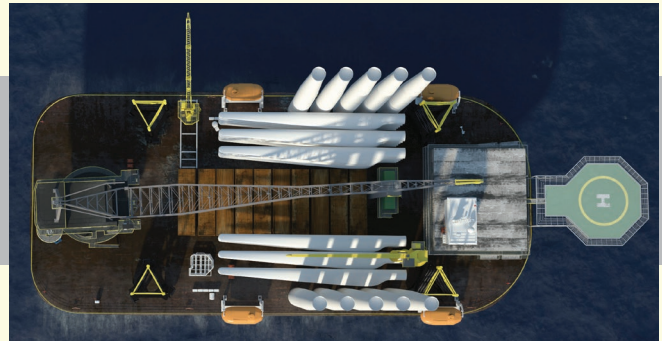

Top view of main deck showing 10 complete sets of wind turbine components.

ZEE RIG 3

Above Deck Quarters Arrangement

- 45 persons (Marine crew and client staff)
- 42 single person staterooms with private bathrooms
- 3 single stateroom suites with private bathrooms
- Office and conference room facilities
- Welfare and recreation facilities

Below Deck Quarters Arrangement

- Meeting rooms
- Lounge, recreation rooms
- Galley, dining hall
- Hospital

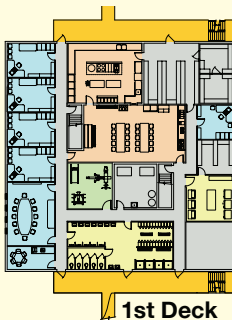

1st Deck

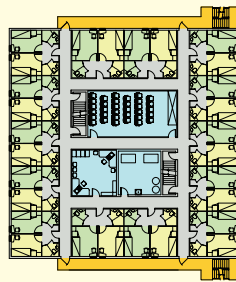

2nd Deck

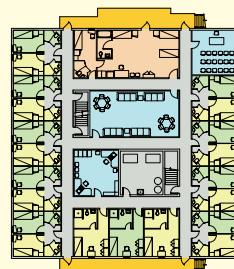

3rd Deck

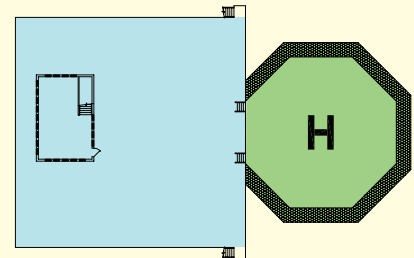

Roof/Pilot House



View of vessel in its current configuration before conversion.

Propulsion

- Self-Propelled and DP-II
- Equipped with 4 Thrusters, each 2,500 HP
360-degree Azimuthing with VFD Drive Systems

Regulatory

- ABS Class, A-1 Self-Elevating Unit
- USCG Certified
- Designed to IMO MODU, SOLAS
- U.S. Flag
- Units can be designed to meet requirements of other regulatory/certification authorities as needed

Vessel Registry

Hull Number: 521808 IMO Number: 87564
Flag Note: U.S. Flag



14800 St. Mary's Lane, Suite 270
Houston, Texas 77079

Tel: +1 281 558 0290
Fax: +1 281 558 0295

E-mail: zentech@zentech-usa.com www.zentech-usa.com

ZEE RIG 3

Marine Crane Barge

- Available for Charter
- ABS-Class certifiable
- Variable load 5,500 US tons (4,990mt)
- Net variable load 5,290 US tons (4,800mt)
- Berthing for up to 45 persons (Marine and Client)
- Additional facilities available below deck
- Helideck rated for Sikorsky S-61, S-92 per CAP-437



Zee Rig 3 shown with AmClyde Model 52 Marine Crane and 275 Ft. (83.8m) Boom.

Main Crane

- AmClyde Model 52 Marine Crane with 275 Ft. (83.8m) Boom, 230 Ft. (70m) to Main Fall.
- Rated 600 US tons at 76 Ft. Radius (544.2mt at 23.2m)
- Boom length may be increased 40 Ft. (12m) to 315 Ft. (95.8m)
- Capacity may be upgraded to 1,025 US tons (1,000mt)
- Crane operable at 40 Feet per Second (12 m/s) wind speed

Zentech is the owner of Zee Rig 3, a marine crane barge with overall length of 400 Ft. (121.9m), breadth of 100 Ft. (30.48m) and hull depth of 29 Ft. (8.8m) and a marine crane of 600 US tons (544.2mt) capacity. The vessel is currently undergoing upgrading in Houston/Galveston, Texas, including new Accommodations block, Helideck, Life Boats and Hull enhancements with dry-docking for ABS class certification.

Zentech is offering the vessel for medium or long-term charter in its current configuration, or depending on client requirements in one of several alternate configurations. Please contact Zentech for more information and a video of this unique vessel.

Utility Crane

- 50 US tons (45.54mt) with 120 Ft. (36.6m) boom.



View from operators cab.

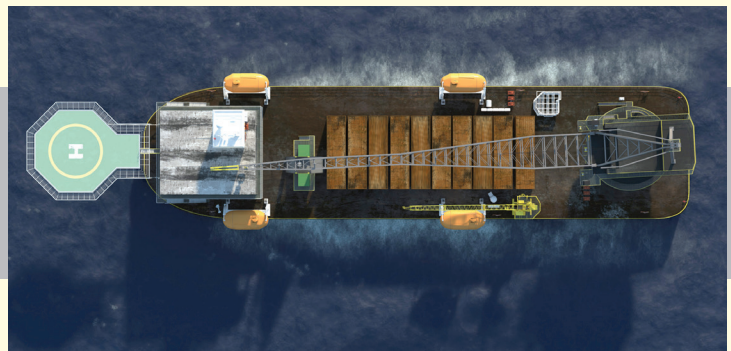

Photo of crane barge working on location for platform upgrading.

Key Dimensions

Key Dimensions		
Hull Length	400 Ft.	121.9m
Hull Breadth	100 Ft.	30.48m
Hull Depth	29 Ft.	8.8m
Hull Draft	18 Ft.	5.5m
Free Deck Space	18,000 Sq. Ft.	1,672m ²
Gross Tonnage	8,094 GRT*	—

* Gross Register Tonnage



Plan view of Zee Rig 3 showing Main Crane and Utility Crane.

ZEE RIG 3

Above Deck Quarters Arrangement

- 45 persons (marine crew and client staff)
- May be configured for single or two person cabins
- Office and conference room facilities
- Welfare and recreation facilities

Below Deck Quarters Arrangement

- Capacity for up to 130 persons below main deck
- Meeting rooms, lounge, recreation rooms
- Hospital
- Galley and dining hall



Close-up of Main and Auxiliary Hooks

Side view showing 275 Ft. (83.8m) boom of AmClyde Marine Crane



1st Deck

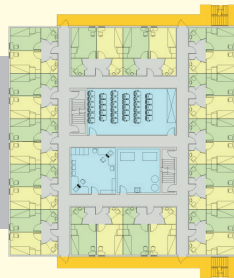

2nd Deck

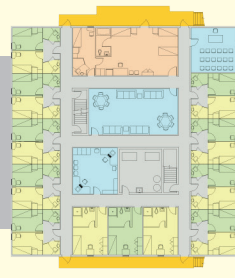

3rd Deck

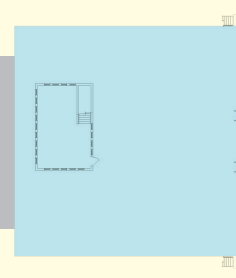

Roof/Pilot House

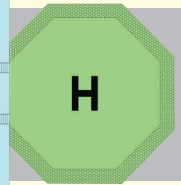

Mooring Equipment

Four each, 2-Drum anchor hoists

Wire Rope: 5,400 Ft. (1,646m) of 2 inch wire (50.8mm), 6 x 25 construction

Maximum Line pull: 130,000 lbs (58.9mt) at 75 Feet Per Minute (22.8 Meters Per Minute)

No-load line speed: 150 Feet Per Minute (45.7 Meters Per Minute)

Maximum brake holding power: 260,000 Lbs. (117.9mt)

Maximum dog holding power: 325,000 Lbs. (147.4mt)

Anchors: 8 each Stockless Anchors, 20,000 Lbs. (9.1mt)

Power

3 each 400-KW, 450-volt, 60-C, three-phase, diesel powered electric generators

Fuel

260,000 Gallons (948,207 liters), sufficient for 45 days' operation

Vessel Speed

Dependent on sea conditions and towing vessels; 7 knots in calm water.

Vessel Registry

Hull Number: 521808

IMO Number: 875661

Flag Note: U.S. Flag